



Messtechnik GmbH & Co. KG



IMS

measuring probes

CD43, CD70

computer displays

SD1

sensor display

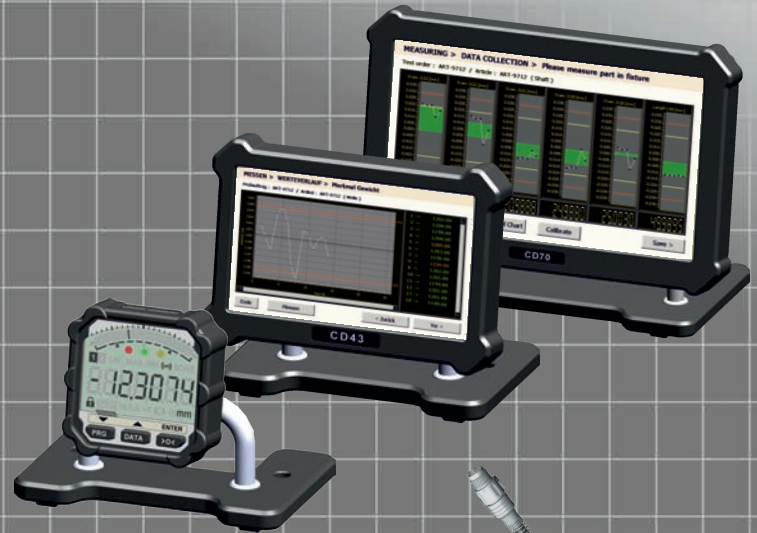

IMS measuring probe series

IMS probe - a new generation of inductive measuring probes with integrated signal processing and digital interface for measuring output.
The new IMS measuring probes are based on the reliable clearance-free ball bearings and the robust inductive measuring principle. But the sensible and sensitive analogue measuring signals are no longer transferred out of the case of the measuring probe via cables and then measured externally by electronics, instead they are processed and digitised directly inside the IMS measuring probes. An innovative measuring principle and highly integrated electronics make possible this milestone of new generation IMS measuring probes.

Comparison of ind. probes

Technical data :

	old	new
Mechanical characteristics	Standard	IMS
Compact tube case, stainless steel 8h6	✓	✓
High protection class for rough environments	✓	✓
Clearance-free ball bearing for precise mea.	✓	✓
Gauge spindle Ø 4, gauge slide M2.5	✓	✓
Actuation by spring, vacuum, compressed air	✓	✓
Cable pluggable at measuring probe for simple mounting / exchange on fixtures	(rarely)	✓
Simple extension of cables without influence on measuring values		✓
Bus cables for drastic reduction of connection cables and wiring		✓
Characteristics of integrated electronics		
Optimal stable sensor signals without influence by cable / external interferences		✓
Individual error correction of each probe		✓
Adjustment tolerance of sensitivity [%]	0.3...0.6	< 0.05
Max. linearity error (+/- 2 mm) [µm]	< 24	< 1
Temperature drift [ppm / °C]	100	20
No error by external measuring electronics		✓
Integrated temperature measurement provides temperature of measuring probe / fixture		✓
Interface		
Simple wiring with ISi connection adapters and pluggable ISi extension cables to a bus with up to 60 probes / sensors (ISi bus)		✓
Identification of IMS measuring probes : Type, serial number, ..., next date of inspection can be requested directly from the probe		✓

Technical data of measuring probe : IMS-5S

Metrological characteristics	
Measuring range	5 mm
Resolution	0.1 µm, optional 0.01 µm
Accuracy	< 1 µm
Measuring rate	2000 measuring values / sec (0.1 µm)
Measuring force	0.7 N (Standard)
Electrical characteristics	
Supply voltage	2.6 ... 3.6 V
Power consumption	2.8 µA / measurement per second
Characteristics of temperature sensor	
Measuring range	-20 °C ... 80 °C
Resolution	0.25 °C
Accuracy	+/- 1.5 °C
Environmental conditions	
Operation / Storage temp.	+32 ... +122 °F / -4 ... +158 °F

Type [Art. No.] Article

IMS-5S [F350 010] IMS probe, 5 mm measuring range, spring pushed / vacuum lifting



IMS-5P [F350 020] IMS probe, 5 mm measuring range, pneumatically pushed



ISi-cca [F390 100] ISi connection cable, axial



ISi-ccap [F390 200] ISi connection cable, axial, pneumatic



ISi-ccr [F390 300] ISi connection cable, radial



ISi-ccrp [F390 400] ISi connection cable, radial, pneumatic



ISi-ca1 [F390 001] ISi connection adapter, single



ISi-ca2 [F390 002] ISi connection adapter, double



ISi-ca4 [F390 004] ISi connection adapter, quadruple



ISi-ca8 [F390 008] ISi connection adapter, octuple



ISi-USB [F390 020] ISi connection adapter for USB



ISM-ISi [F620 200] ISi radio module for ISM band

BLE-ISi [F605 200] ISi radio module for Bluetooth BLE



Capability of connection for IMS probes

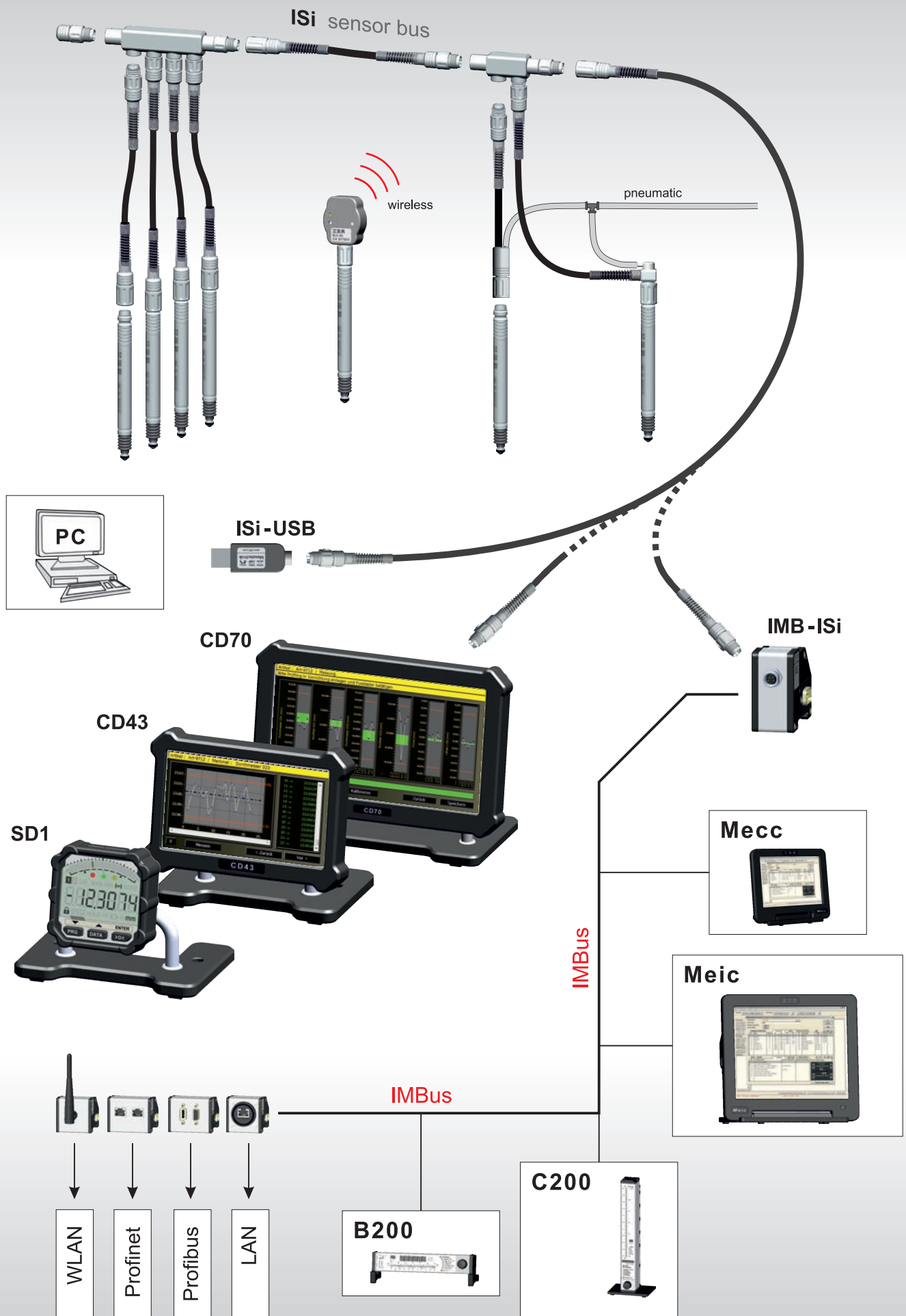

SD1 a universal sensor display

The sensor display unit **SD1** was especially developed for industrial use. The robust aluminium case with rubber shock protection as well as a high protection class allow usage in rough manufacturing environment. The display is rotatable, a numeric display shows the measuring values with high resolution and an analogue display with coloured LEDs presents clearly the tolerance status of the component.

The sensor display SD1 features a large scope of operation and can be configured freely for the particular application as required by a windows software. Thereby functions can be removed or activated and settings can be initialized.

Image : Front panel

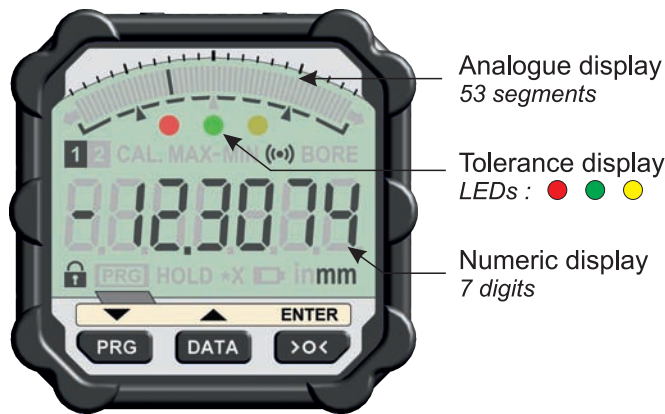

- Analogue display
53 segments
- Tolerance display
LEDs : ● ● ●
- Numeric display
7 digits

Image : Back panel

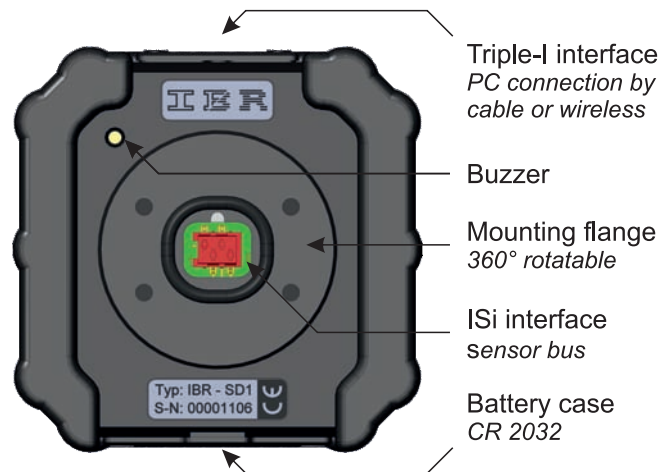

- Triple-I interface
PC connection by
cable or wireless
- Buzzer
- Mounting flange
360° rotatable
- ISi interface
sensor bus
- Battery case
CR 2032

Technical data :

Mechanical characteristics	
Case	Aluminium, rubber shock protection
Front plane	Acryl glass (scratch-proof)
Dimensions / Weigth	(WxHxD) 60 x 59.5 x 21.7 mm / 95 g
Electrical characteristics	
Power supply	Battery (CR2032)
Battery lifetime	approx. 8000 h (SD1 with probe)
Measuring rate	adjustable, 2 ... 20 values / sec
LCD display	
Display type	Liquid crystal display, reflective
Numeric display	7 digits (10.5 mm)
Analogue display	53 segments
LEDs / Acoustical output	
Tolerance display	3 LEDs : 1x red, 1x green, 1x yellow
Buzzer	Piezo
Connections	
ISi interface	Bus connection for sensors, hand / foot switch, tolerance adapter, ...
Triple-I interface	Connection for IBR radio modules or cable with USB / RS232 interface
Measuring systems	
The measurands : measuring range, resolution, precision, ... are defined by the connected measuring probe or sensor. Example : Measuring probe IMS-5S → Range 5mm, Resolution 0.01µm	
Environmental conditions	
Operation / Storage temp.	+41 ... +113 °F / -4 ... +158 °F
Protection class	IP65 (CEI / IEC 529)
EMC according to EN50081 - 2 and EN50082 - 2	

Software functions :

Basic functions	
Unit / Measuring direction	mm, inch / positive, negative
Resolution	0.001 / 0.0001 / optional 0.00001 mm
Measuring inputs	
Number	2
Combination by factors	±0.001 ... ±59.999 per measuring input
Measuring mode	
Static measurement	Yes / optional Hold mode
Dynamic measurement	Min, Max, TIR, Mean, Bore
Calibration	
Zero adjustment / Preset	with one master
Calibration	with two masters (gain & offset)
Forced calibration	by temperature change or elapsed time
Tolerance limits / Grading	
Tolerance type	Absolute tolerance limits or nominal size with relative tolerances
Number of grades	2 ... 30
Handling and communication	
Favorite buttons	freely definable for each button
Hand / foot switch	send measuring value, calibrate, ...
Tolerance adapter	output tolerance status / grade
Triple-I interface	measuring value output, programming
Password protection	for programming / for calibration
Configuration of analogue display	
Display mode	Bargraph / Single segment
Bargraph origin	Left / Center / Right
Special features	
Windows software for configuration of sensor display SD1	

SD1 applications :

SD1 used as dial gauge display with probe

Image : SD1 dial gauge set

- SD1 sensor display
- SD1 measuring probe holder
- IMS probe



Image with radio module



SD1 sensor display on mounting bracket

Image : SD1 set for mounting

- SD1 sensor display
- SD1 ISi connection adapter (rotatable)
- SD1 mounting bracket (slewable)

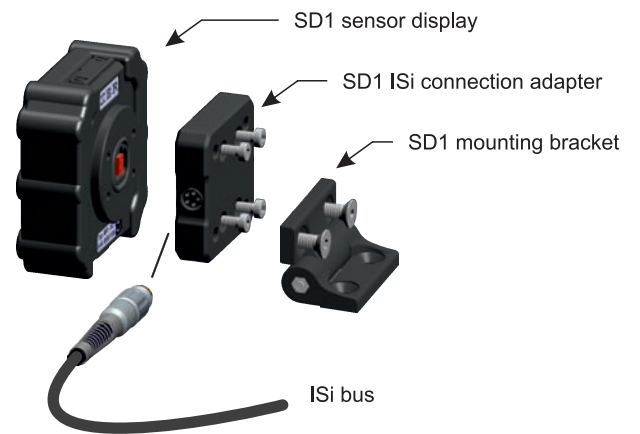

SD1 sensor display on pedestal

Image : SD1 set with foot

- SD1 sensor display
- SD1 ISi connection adapter
- SD1 pedestal (slewable)



SD1 survey :

Type	[Art. No.]	Article
SD1	[F421 010]	Sensor display with rotatable carrier and ISi bus connector.



SD1 feature survey

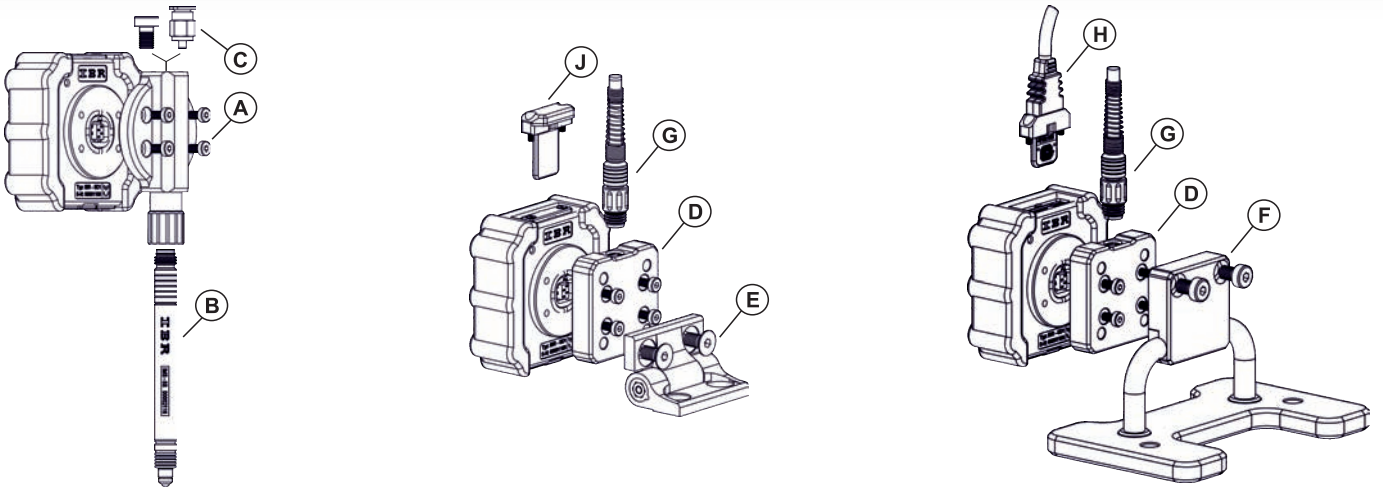

- (A) SD1 measuring probe holder [F421 021]** Holder for mechanical and electrical connection of measuring probes from the IMS series.
- (B) IMS measuring probe** Further information please see survey of IMS probe series.
- (C) Pneumatic connector** Use of standard pneumatic elements with M5 thread.
- (D) SD1 ISi connection adapter [F421 022]** Connection adapter for mounting SD1 sensor display to a pedestal or bracket, with M8 connector for ISi connection cables.
- (E) SD1 mounting bracket [F421 025]** Slewable bracket for mounting of SD1 sensor display with ISi connection adapter.
- (F) SD1 pedestal [F421 026]** Pedestal with rotatable carrier for mounting of SD1 sensor display with ISi connection adapter.
- (G) ISi connection cable** Further information please see survey of ISi connection cables.

SD1 Connection cables and wireless modules for data output

- (H) 3i-USB [F420 010]** Triple-I connection cable for USB interface



- (H) 3i-232 [F420 020]** Triple-I connection cable for RS232 interface



- (J) ISM-3i [F620 100]** Triple-I radio module for ISM band
- BLE-3i [F605 100]** Triple-I radio module for bluetooth BLE



SD1 short operating instruction :

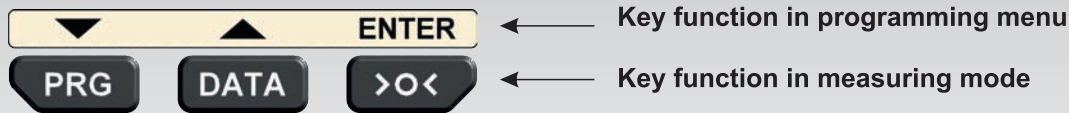

Key functions in :		Measuring mode	Programming menu
PRG		Call programming menu	▼ Decrease flashing display (- 1)
> 2 sec.		Freely programmable favorit key	Exit programming menu
DATA		Data transfer Start / Stop dynamic measurement	▲ Increase flashing display (- 1)
> 2 sec.		Freely programmable favorit key	- - -
>O<		Zero adjustment	ENTER Confirm flashing display
> 2 sec.		Freely programmable favorit key	Exit menu item

Windows configuration software SD1_Win.exe

Menu view on SD1 LCD display

- Unit
- rESoL.
- dir.
- PrESEt
- 2-CAL.
- dt.-CAL.
- tF.-CAL.
- Factor / ProBES
- SEt. OP.
- GrAdinG
- SEt. Pnt.
- SEt. toL.
- toL. LED
- CoL. diS.
- hoLd
- but. PRG.
- but. dAtA.
- but. CAL.
- FootS.
- P.C. ProG.
- P.C. CAL.
- Auto.oFF
- SA.rAtE
- BEEP

CD43 a computer display for industrial use

The computer display **CD43** is a small and powerful display unit for measuring applications, which cannot be simply solved by using dial gauges. The robust aluminium case as well as a high protection class allow usage in rough manufacturing environment. The new sensor interface ISi bus allows connection of up to 60 measuring probes, sensors, hand- and foot switches. For fast and simple solving of measuring applications as well as for trend display of the production process, the CD43 is delivered with the user-friendly software ComGage Level 1.

Features

- Compact and robust construction with solid, sealed metal case (incl. connector caps for IP64), passive cooling and 4.3" TFT-Display (480 x 272) with touch screen, adjustable angle of tilt.
- ISi sensor bus for connecting 1...60 IMS probes, sensors, hand / foot switches, tolerance adapters.
- USB host (mouse, keyboard, USB stick) and USB client (data exchange with PC).

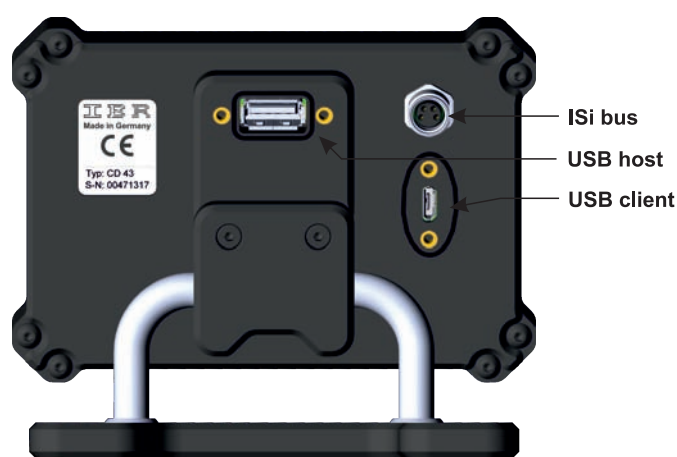

Order information :

Computer display CD43	Art. No. F235 010
-----------------------	-------------------

Technical data :

Mechanical characteristics	
Case with foot	Aluminium powder -coated
Dimensions / Weight	(WxHxD) 118 x 95 x 72.5 mm / 420 g
Protection class	Front side IP65, CEI / IEC 529 Rear side IP64 with connector caps
Electrical characteristics	
External power supply	100 ... 240 VAC, 6 Watt
Max. power consumption	1.8 Watt (without sensors)
Computer characteristics	
Display	4.3" TFT, resolution 480 x 272 (adjustable angle of tilt)
Touch Screen	4 - wire analogue resistive
CPU	Vybrid VF50, 400 MHz
Memory	128 MB RAM, 128 MB Flash
Operating system	Windows CE 6
Measuring software	ComGage Level 1
Connections	
Standard PC connections	1 x USB client, 1x USB host
ISi - Interface	60 sensors / clients
Environmental conditions	
Operation / Storage temp.	+41 ... +113 °F / -4 ... +158 °F

CD43 application

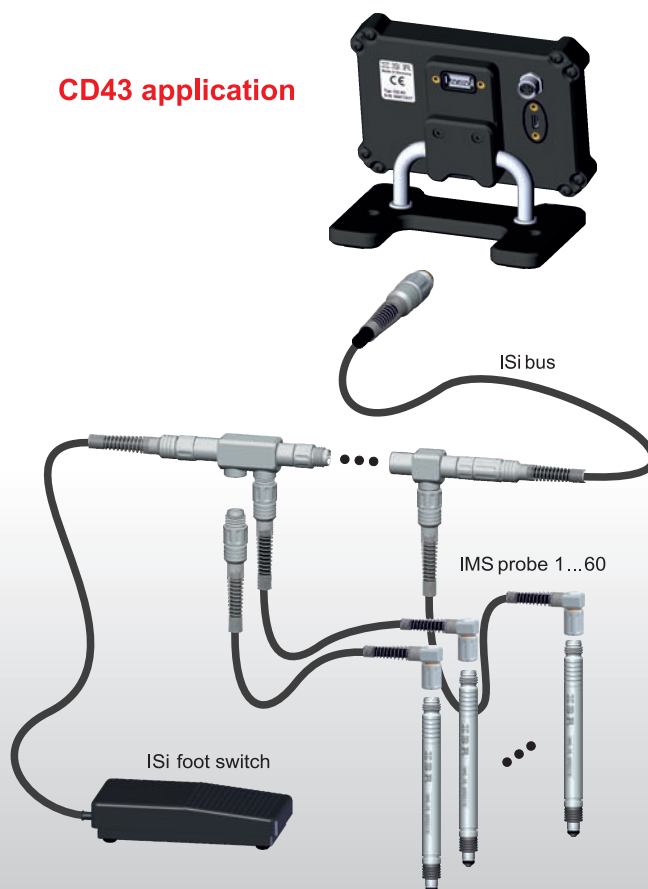

CD70 a computer display for industrial use

The computer display **CD70** is a compact and powerful display unit for measuring applications, which cannot be simply solved by classic gauges like e.g. column gauges and digital gauges. The robust aluminium case as well as a high protection class allow usage in rough manufacturing environment. The new sensor interface ISi bus allows connection of up to 60 measuring probes, sensors, hand- and foot switches. For fast and simple solving of measuring applications as well as for trend display of the production process, the CD70 is delivered with the user-friendly software ComGage Level 1. An upgrade to ComGage Level 2 is possible.

Features

- Compact and robust construction with solid, sealed metal case (incl. connector caps for IP64), passive cooling and 7.0" TFT-Display (800 x 480) with touch screen, adjustable angle of tilt.
- ISi sensor bus for connecting 1...60 IMS probes, sensors, hand / foot switches, tolerance adapters.
- USB host (mouse, keyboard, USB stick), USB client (data exchange with PC) and LAN connection.

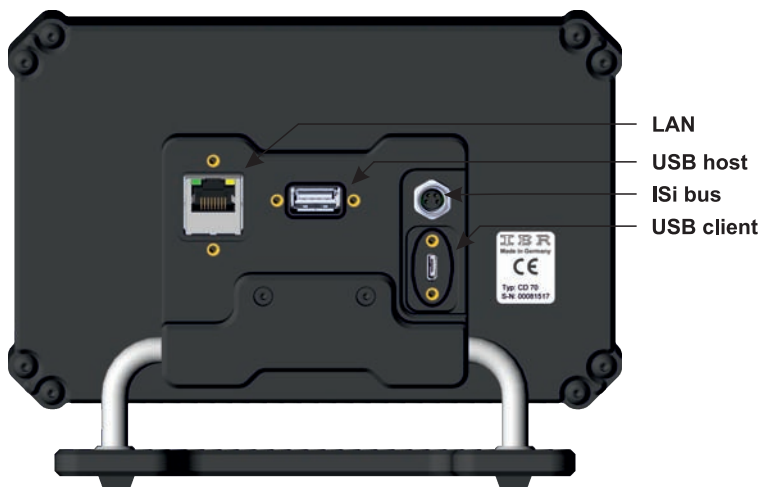

CD70 application



Order information :

Computer display CD70	Art. No. F235 050
-----------------------	-------------------

Technical data :

Mechanical characteristics	
Case with foot	Aluminium powder - coated
Dimensions / Weight	(WxHxD) 184 x 135 x 87,5 mm / 1.0kg
Protection class	Front side IP65, CEI / IEC 529 Rear side IP64 with connector caps
Electrical characteristics	
External power supply	100 ... 240 VAC, 6 Watt
Max. power consumption	2.4 Watt (without sensors)
Computer characteristics	
Display	7.0" TFT, resolution 800 x 480 (adjustable angle of tilt)
Touch Screen	4-wire analogue resistive
CPU	Vybrid VF50, 400 MHz
Memory	128 MB RAM, 128 MB Flash
Operating system	Windows CE 6
Measuring software	ComGage Level 1 / ComGage Level 2
Connections	
Standard PC connections	1 x USB client, 1 x USB host, 1 x LAN
ISi interface	60 sensors / clients
Environmental conditions	
Operation / Storage temp.	+41 ... +113 °F / -4 ... +158 °F

ComGage Level 1 / Level 2

The software **ComGage Level 1 / Level 2** are universal programmes for fast solving of measuring applications. The software is easy to handle and is optimized especially for the computer displays CD43 and CD70 with touch operation.

Features

	ComGage Level 1	ComGage Level 2
Number of characteristics / Number of measuring inputs	8 / 60	20 / 60
Measurement of characteristics in freely definable groups with additional input of operator instructions	✓	✓
Input of formula for probe mixing (Support of all arithmetical and trigonometrical functions)	✓	✓
Static measuring mode with live display, as well as dynamic measuring modes : Min, Max, TIR, Mean, ...	✓	✓
Input of measuring value by touch / keyboard	✓	✓
Export functions for collected measuring values	xls, csv	xls, csv, QDAS
Reference information data input together with measuring values (Operator, Machine, ...)		✓
Trend display for collected measuring values (= run chart)	✓	✓
Statistical analysis by control charts, histograms, Cp/Cpk		✓
Control tasks by digital inputs / outputs as well as measuring value output via RS232 / radio modules	simple	advanced
Compatible to ComGage Professional	✓	✓

Image : Programming of characteristics

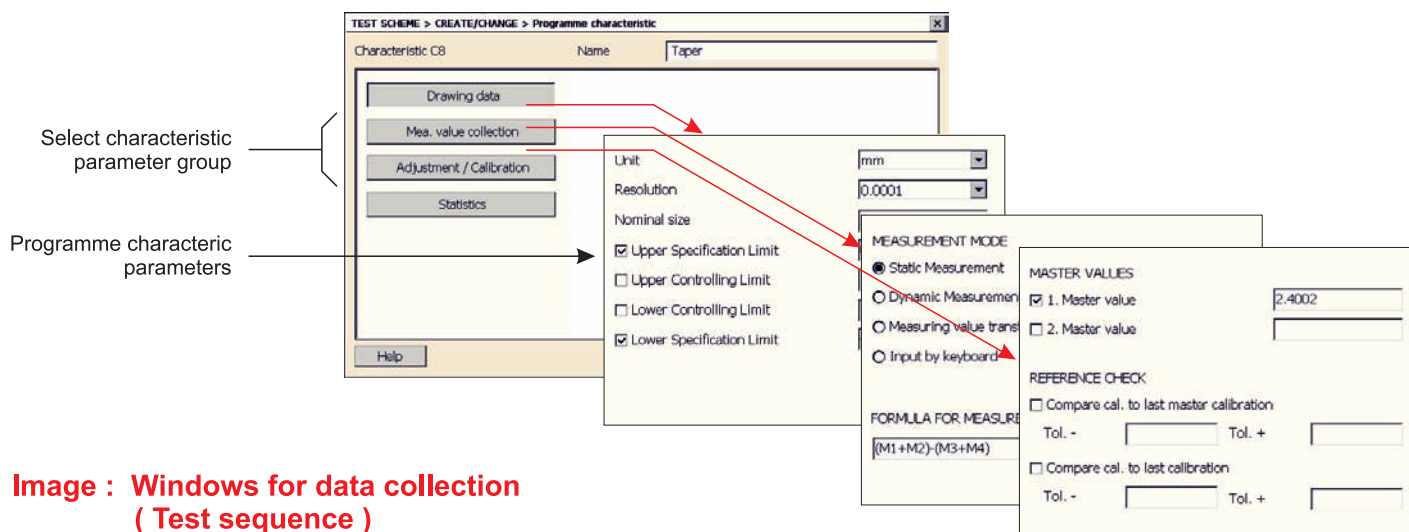
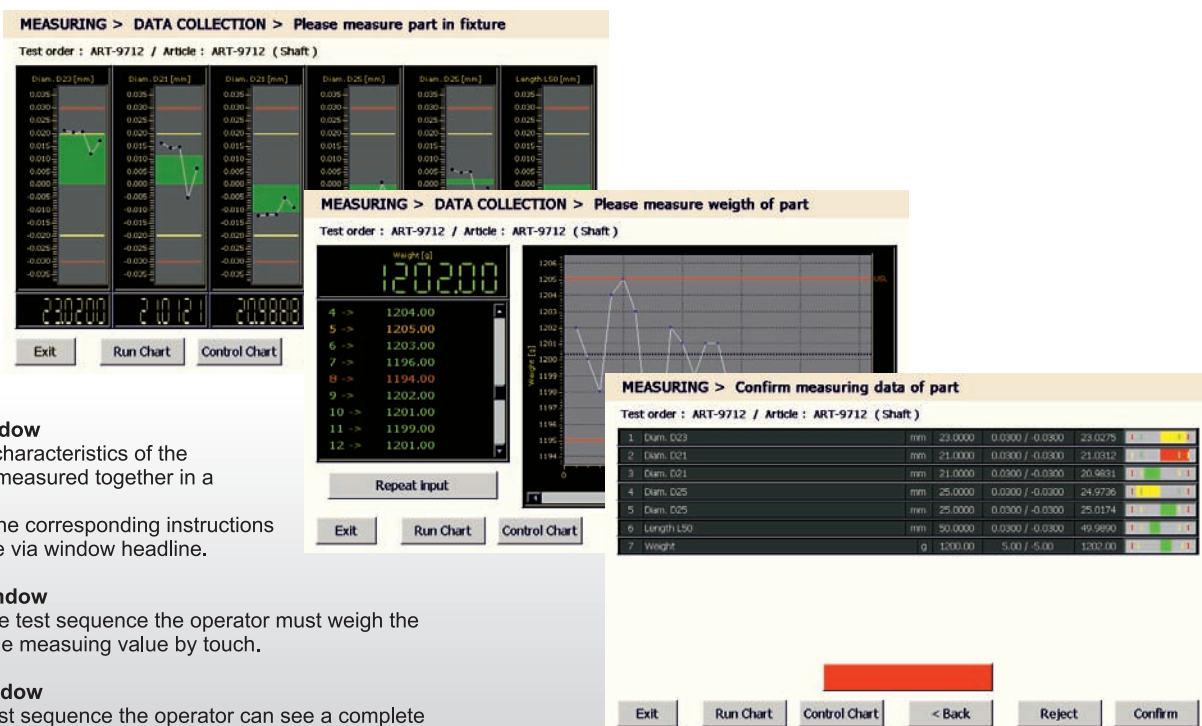

Image : Windows for data collection (Test sequence)



Description of 1st window

In the test sequence 6 characteristics of the component are initially measured together in a measuring fixture.

The operator receives the corresponding instructions for measuring sequence via window headline.

Description of 2nd window

In the second step of the test sequence the operator must weigh the component and enter the measuring value by touch.

Description of 3rd window

In the last step of the test sequence the operator can see a complete summary of all characteristics of the measured component and can now decide, whether the measuring values shall be stored inside the database.

ComGage Level 1 / Level 2

Image : Online -SPC windows



Run chart in ComGage Level 1 and Level 2

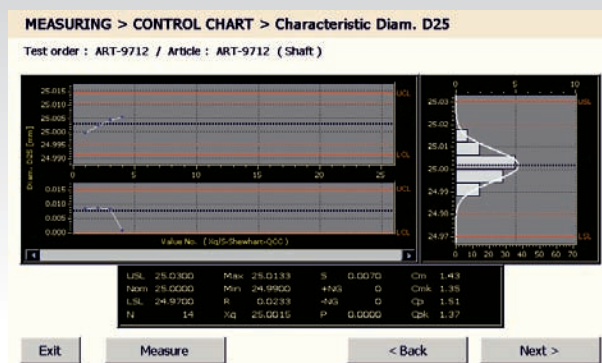

Control chart in ComGage Level 2

Further software support for CD43 / CD70 computer displays

Programming of test schemes using ComGage Professional on PC

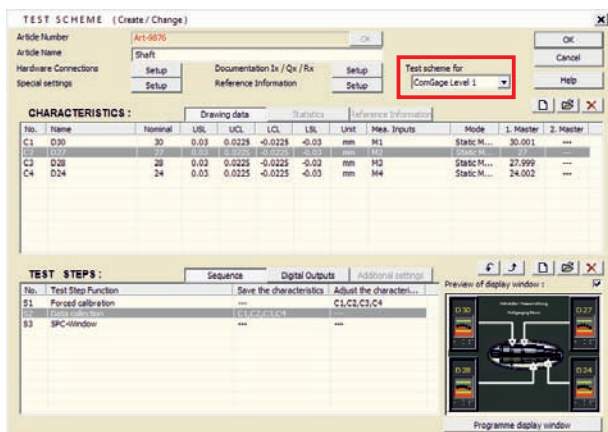

The ComGage Professional menu for programming test schemes allows to specify, that the new test scheme shall be executable with ComGage Level 1.

In contrast to programming with ComGage Level 1 / 2, the programming menu of ComGage Professional allows programming of test steps with freely designable display windows and individual control of digital inputs / outputs.

Administration, analysis and export of measured values by ComGage Professional

ComGage Professional allows creating test orders for test schemes created with ComGage Level 1 / 2. The test orders allow storage of measured data separately for production orders, production lots, ... and can be filled with measured data using ComGage Level 1 / 2.

The measured values collected with ComGage Level 1 / 2 can be exported or analysed using ComGage Professional afterwards.

Order information :

ComGage Level 1	Art. No. F722 010
ComGage Level 2	Art. No. F722 020

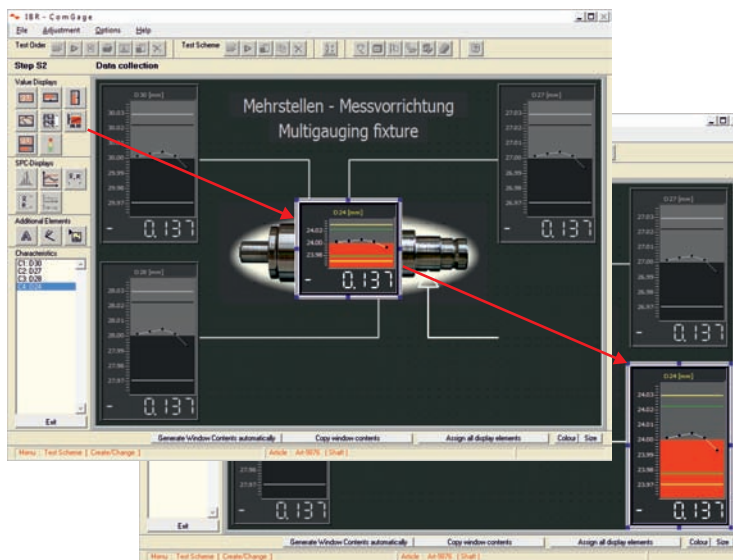

For guiding the operator through the measuring sequence freely designable display windows can be created for ComGage Level 1 / 2. These display windows can contain pictures, lines and texts.

Access to flash memory of CD43 / CD70 computer displays via USB

On connection of a CD43 / CD70 via USB client connector (Micro-USB) to a Windows PC, the flash memory of the CD43 / CD70 computer display can be directly accessed via Windows Mobile Device Center Software.

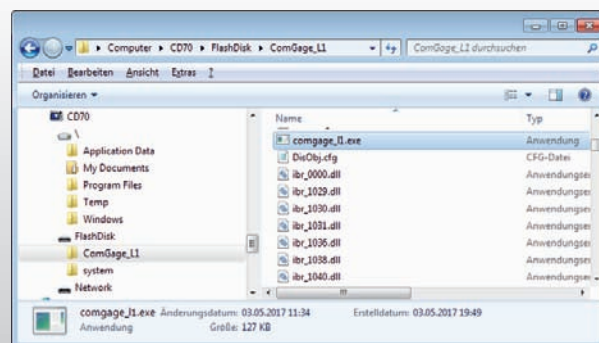

Software support

SD1_Win / SD1_Configurator

SD1_Win Windows programme / SD1_Configurator Android app for configuration of SD1 sensor displays.

ISi_Test

ISi_Test is a universal program for initialisation, calibration and test of all ISi sensors.

IBR_DDK.DLL

Universal Device Driver Kit for linking all IBR measuring and interface instruments in Win 2000 ... Win 10 and CE programs. (Examples for VC++, VB, LabView, Delphi, ... available)

IBR_VCP

COM-Port simulation program for software packages without USB, LAN and WLAN support. Simulation of older multiplexers (e.g. MUX50, MUX10, ...) for software packages without ISi-Bus, IMBus & IBRit-rf1 support.

IBREXDLL

Excel-Workbook for reading in, visualising and analysing measurement data in MS-Excel.

ComGage

Software for metrology and statistical process control in manufacturing facilities.

Head office of IBR Messtechnik GmbH & Co. KG



Messtechnik GmbH & Co. KG

Ringstraße 5
D - 36166 Haunetal
Germany

Tel. : +49 (0)6673 90091-0
Fax. : +49 (0)6673 90091-100
E-Mail : info@IBR.com
Web : <http://www.IBR.com>