



Leica A60 S / Leica A60 F

The stereomicroscope system for high productivity in the electronics and medical device manufacturing industries

Living up to Life

Leica
MICROSYSTEMS



Your work in focus

An intuitive microscope system that knows what you need

Increased productivity, optimum visibility of products and components, easy processing of subassemblies – industrial production of electronic components and medical devices requires a highly specialized microscope.

High productivity, low costs

Optimally suited to the requirements of micro-manufacturing, the Leica A60 stereomicroscope system can effectively increase productivity. With sophisticated Leica Microsystems' precision optics, working with the microscope is significantly faster and more convenient. A low cost of ownership makes the Leica A60 an investment that pays off.

Comfort and convenience during work can enhance production quality

Ergonomic design is a prerequisite for increased comfort and convenience during work and more performance capacity, which can lead to a higher quality end product. The Leica A60 is optimized for long periods of continuous use, can be used intuitively, and quickly adapts to different users.

Two types of illumination for accurate work

The Leica A60 offers two types of LED illumination, for matte or reflective specimens, to ensure fatigue-free, accurate work.

Selecting the microscope

The Leica A60 stereomicroscope does not require the user to be a microscope expert. The components of the preconfigured system are perfectly matched to each other to provide easy operation with the best optical results.

Choose between two different stands: the Leica A60 F with flex arm for maximum freedom of movement or the Leica A60 S with swing arm for high stability.

See more of the sample

What does FusionOptics™ mean?

Conventional stereomicroscopes have two identical beam paths that reveal a spatial impression of the sample. Leica Microsystems' innovative FusionOptics™ technology, on the other hand, takes advantage of a neurological phenomenon: the microscope's left beam path has a great depth of field, while the right beam path shows an image with super-high resolution. The human brain then combines the best information from both channels, to compose a high resolution image with a great depth of field never achieved in any stereomicroscope before.

The best magnification for the task

For optical inspection in production, maximum magnification is not the most important aspect. A much more important feature is magnification that enables a large surface overview of the entire workpiece – like that provided by the Leica A60. The Leica A60 begins with 5× magnification, and for detailed observation, 30× magnification.

From a quick overview to the smallest detail

In most cases, components examined under a stereomicroscope in production are only a few millimeters in size. However, the entire workpiece is substantially larger. The Leica A60 offers a magnification range from 5× to 30×, which enables both a large surface overview and detailed observation; with consistent sharpness and without time-consuming refocusing. This saves valuable time.

Large object field for maximum overview

Large samples frequently have multiple areas that need to be examined. The greater the number of areas of interest in the field of view at once, the faster, more accurate, and convenient work becomes. With a 46mm object field, the Leica A60 reveals up to 80% more surface area than comparable microscopes. This means more comfort and convenience, and time savings.

Eagle eye in the millimeter range

With a depth of field of up to 13.6mm, the Leica A60 has a depth of field that is approximately twice that of comparable stereomicroscopes without FusionOptics™ technology. Practically speaking, this means that all areas within a height of up to 13.6mm are displayed in sharp focus, without refocusing. Working with the microscope becomes more comfortable, convenient, and efficient.

More room for work

Often, manual tasks such as resoldering are performed while components are viewed under the stereomicroscope. With a working distance of up to 122mm, there is enough room to carry out even complex procedures comfortably, accurately, and without microscope contact. The high-quality optics of the Leica A60 are protected from harmful soldering fumes by an interchangeable protective glass.

DEPTH OF FIELD
 DEPTH OF FIELD
 DEPTH OF FIELD
 DEPTH OF FIELD
 DEPTH OF FIELD
 DEPTH OF FIELD
 DEPTH OF FIELD
 DEPTH OF FIELD

Save time when focusing, provided by a depth of field of up to 13.6mm



Easy sample viewing with an object field that is up to 80% larger

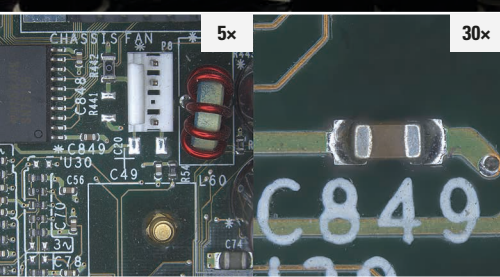

Large range of magnifications for overviews and detailed views



Working distance of 122mm means there is plenty of room for tools

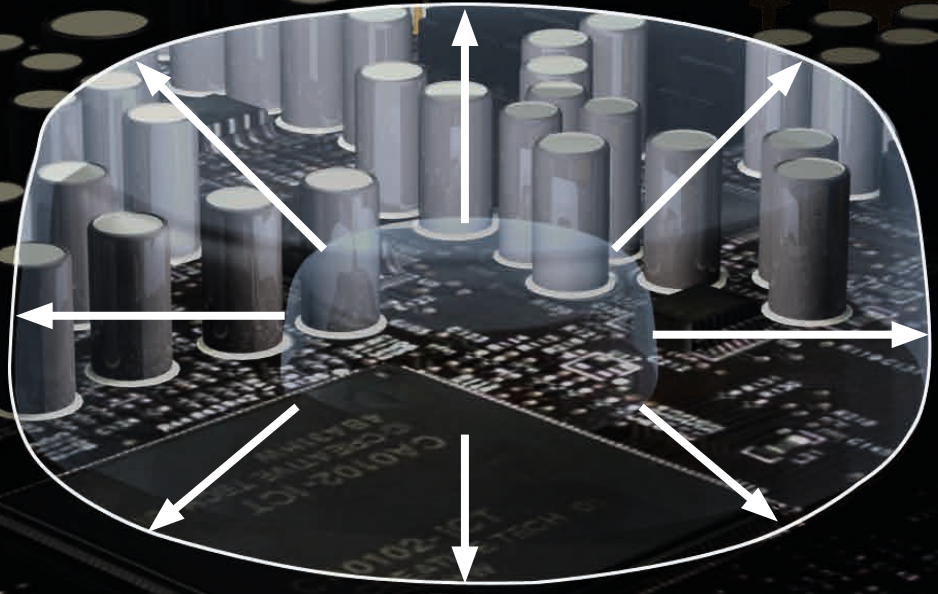



Illumination options

The best illumination for every application

The Leica A60 is equipped with a bright, uniform LED ring illuminator plus removable diffuser. The outstanding feature of the ring illuminator is its daylight-like spectrum, which corresponds to the human eye's perception of neutral white. This allows details in different colors to be identified equally well and defects to be identified.

Find defects quickly and accurately

The dimmable LED ring illuminator brings the finest details to light, even on dark specimens. This makes finding defects on matte surfaces faster, more accurate, and more relaxed for the user.

Diffused light for better vision

When working with highly reflective surfaces such as metal or soldering joints, a diffuser is recommended. The diffused light, which is similar to a circular neon lamp, minimizes bothersome reflections and shiny spots. The finest details, such as microcracks in soldering joints, become visible. The diffuser makes work easier on the user's eyes and makes it easier to concentrate – a bonus for productivity.

Changing lamps is no longer necessary

The state-of-the-art, powerful LEDs used in the Leica A60 have an average lifetime of 50,000 hours with very low power consumption. There is no need to change lamps, and no downtime. Cost of ownership is reduced and LED is energy-saving illumination.

The optimized LED ring illuminator

The LED ring illuminator is more than a circular arrangement of LED lamps. For the best light efficiency, a specially calculated focus lens is placed in front of each LED lamp. The LED ring illuminator provides optimum illumination of the work surface and creates the greatest possible brightness.



Always easily accessible: the operating elements of the Leica A60 ring illuminator



The focusing lenses of the ring illuminator optimize brightness and illumination



Maximum brightness for matte, dark specimens

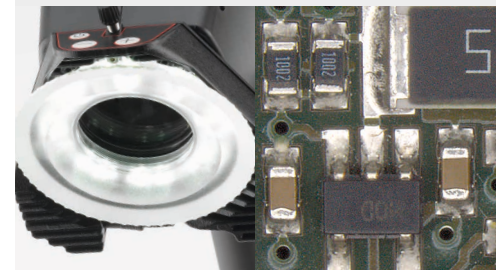

Diffused light reduces reflections on metallic surfaces, e.g., soldered joints

Hard facts about hardware



The 38° viewing angles of the Leica A60 corresponds to natural head posture



The mechanical design, established for 10 years, protects your investment

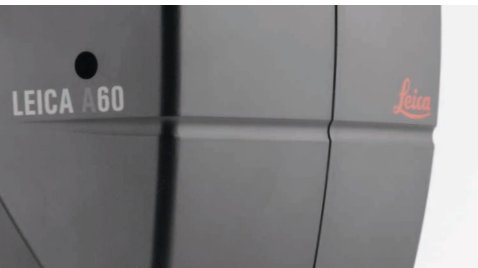

The patented plastic housing prevents static charge



In one step, the microscope workstation becomes a regular workbench

Ergonomics for high performance

Ergonomically designed workstations have been proven to increase performance and the quality of work results. Leica Microsystems' many years of experience in ergonomics is evident in the Leica A60: The 38° viewing angle of the Leica A60 is close to a person's natural head posture. The zoom and focus knobs could not be more accessible; the rheostat of the focus drive can be adjusted to the preferences of a specific user. The operating elements of the Leica A60 ring illuminator are also intuitive and easily accessible, by left and right-handed users alike.

Dual use of the workstation

The Leica A60 offers two stand solutions for optimum utilization of the workstation. During microscope use, both the swing arm and the flex arm are compact enough to offer the maximum possible amount of room. When the microscope is not in use, simply swing it off to the side. This provides room for other tasks. As the Leica A60 does not have any additional controls or cables, it also contributes to a neat, productive work environment.

Sturdy mechanical parts – little downtime

Where manufacturing processes are run around the clock, the demands on man and machine are high. In this environment, the sturdy, well-designed construction of the Leica A60 is evident: The microscope's components have been tested under tough production conditions.

Safer for critical components

With its high degree of ESD dissipation, the patented, antistatic plastic of the Leica A60 housing helps to protect against damage caused by static electricity in ESD sensitive production areas.



Two options to choose



Choose between two different stands

Leica A60 F with flex arm or Leica A60 S with swing arm. Both stands are ideal for viewing large samples and for working at a work table. By simply swinging the stand arm in or out, the work surface can be used for other tasks at any time.



1 Highlights of the Leica A60 F

- Easy viewing of the sample in x and y directions
- Easy height adjustment for different sample heights
- Maximum space savings provided by table clamp fastening

2 Highlights of the Leica A60 S

- For recurring samples
- Features its own grounding point on the base
- Particularly high stability for working at high magnification levels

Optimized electronics production

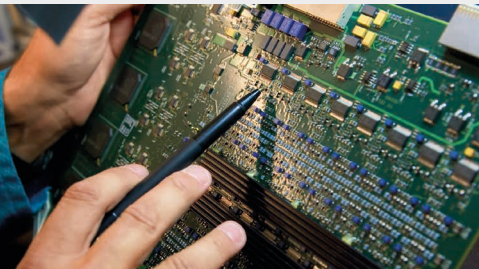

Inspection of printed circuit boards

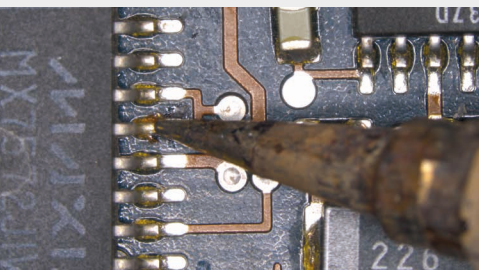

Resoldering chips

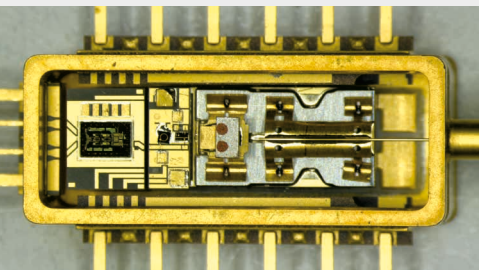

Inspection

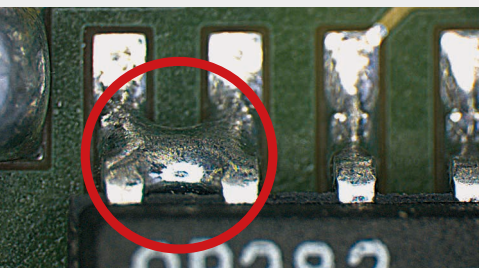

Time-critical production

Inspection of printed circuit boards made easy

The optics of the Leica A60 make inspecting and reworking printed circuit boards easy.

- Large overview with a 46mm object field
- Approximately 100 % greater depth of field makes resoldering work easy
- Convenient handling of soldering iron and test probe with a large working distance of 122mm

One illuminator – two illumination types

The Leica A60 offers an illuminator that enables a view of both detail-rich workpieces and highly reflective samples.

- LED ring illuminator for bright, uniform illumination
- Attachable diffuser for viewing reflective specimens without bothersome shiny spots
- Fast amortization: durable, power-saving LED illumination (at the same brightness, provides energy savings of up to 80 % compared to conventional halogen cold light sources)

Optimum use of the workstation

If a separate microscope workstation is not available, both stand variations – swing arm and flex arm – are ideal.

- Minimal space requirements
- Greatest possible amount of room for work
- Can swing out of the way easily, clearing the workstation for other tasks

Safer for sensitive components

Because protection against static charge is required for tools used in ESD sensitive environments, the Leica A60 has an ESD-protected design.

- Patented, antistatic polymer housing
- High degree of ESD protection helps safeguard your products



Precision for medical device manufacturing

Optimizes productivity and quality

The Leica A60 is optimized for applications in which components have to be assembled, glued, soldered, and reworked.

- Large object field of 46mm provides good overview of the device
- Approximately twice the depth of field makes installation work easy
- Saves time, as refocusing is rarely necessary
- Convenient handling of tools with a large working distance of 122mm

The illumination: powerful yet energy-saving

Because medical components in frequently consist of reflective metal that causes bothersome shiny spots during viewing, the Leica A60 offers two types of illumination.

- Bright, uniform illumination of the sample provided by LEDs with focus lenses in front
- Comfortable, convenient viewing of reflective samples with the attachable diffuser
- Virtually no lamp replacement due to long lifetime, powerful LEDs
- Low power consumption

Ergonomically designed

The Leica A60 benefits from Leica Microsystems' expertise in ergonomic design.

- 38° viewing angle for natural head posture
- Special eyepieces for eyeglass wearers
- Perfectly matched position between zoom and focus knob for tension-free work

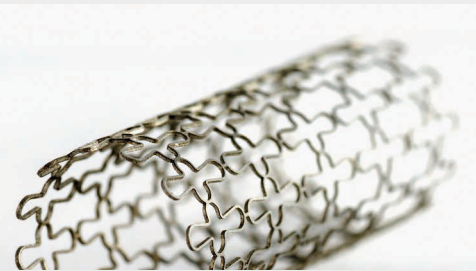

In a stent, mechanical precision is a matter of life and death



Good example of extreme miniaturization: state-of-the-art hearing aid



Reliability could not be more critical: the cardiac pacemaker



Dimensioned drawings

The large object field and unparalleled depth of field make the Leica A60 ideally suited for production and processing of larger samples. The swing arm and flex arm offer a great degree of freedom for working in different areas:

- Laboratory instruction/experiments
- Precision mechanics
- Plastics industry
- Forensic investigation
- Specimen dissection and preparation
- Dental work

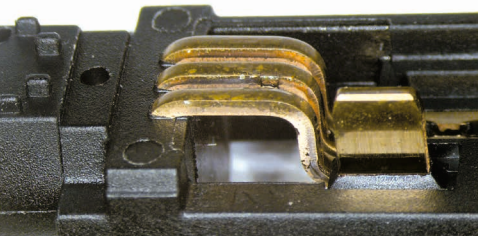

Inspection of plug sockets in die-casting



Oxidation on gear wheel



Attention to details requires high attention and skills

Leica A60 F

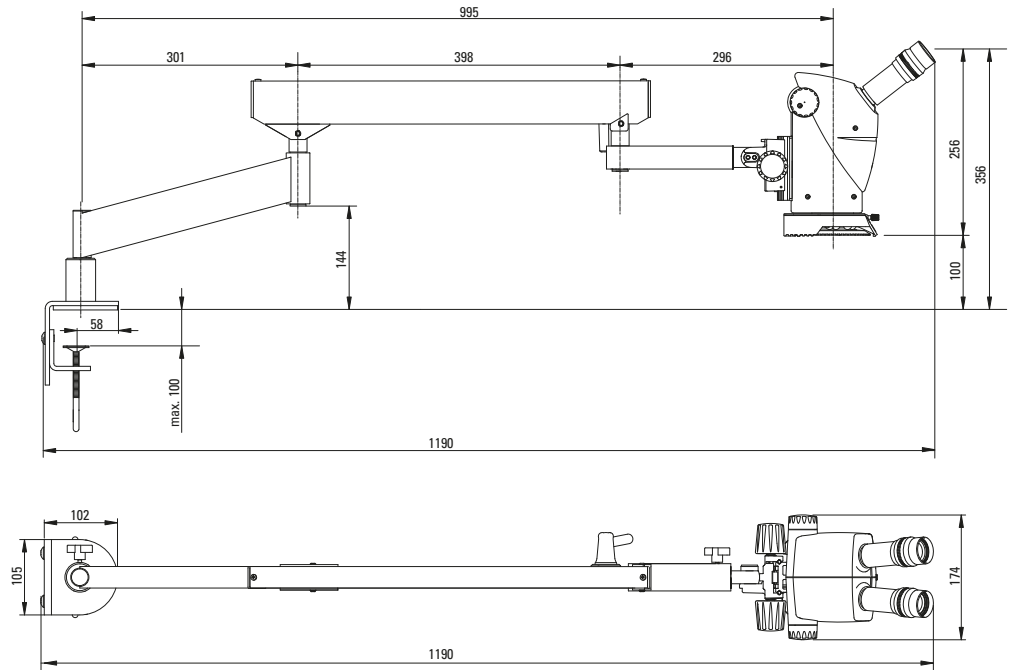

Leica A60 S

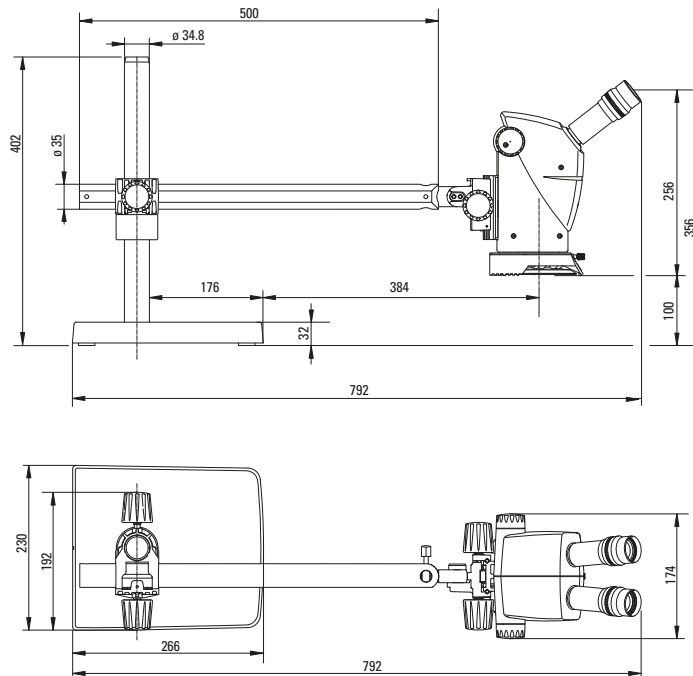

Specifications

Optical Data	
Optical system	Greenough, with Leica FusionOptics™
Convergence angle	10°
Zoom factor	6:1
Zoom range	5× – 30×
Working distance	122mm (without illumination)
Viewing angle	38°
Max. object field	46mm
Max. depth of field	13.6mm
Eyepieces	10×/23 B, Adjustable, suitable for eyeglass wearers
Interpupillary distance	52 – 76mm
ESD protection	Antistatic polymer housing
Protection of optics	Interchangeable protective glass

Order Numbers	
10 450 310	Leica A60 S, with swing arm stand
10 450 311	Leica A60 F, with flex arm stand
10 445 661	Power cable, 2 m, USA
10 445 662	Power cable, 2 m, EURO
10 280 636	Power cable, 2.5 m, 3-pole, Switzerland
10 445 663	Power cable, 2 m – 2.5 m, BS
10 450 012	Power cable, 2 m, Argentina, Type K
10 450 013	Power cable, 2 m, Australia, Type F
10 450 014	Power cable, 2 m, China, Type L
10 450 015	Power cable, 2 m, Israel, Type I
10 450 016	Power cable, 2 m, Italy, Type E
10 450 017	Power cable, 2 m, South Africa, Type D

LED Ring Light	
Number of LEDs	16 Med Power SMT LEDs
LED service life	50,000 hours
Color temperature	5600 K
Controls	On/ Off, brightness (10 increments)
Max. power consumption	15 Watts
Power supply	100 – 240 V, 47 – 63 Hz, 0.55 A

Spare Part Numbers	
10 447 039	Dust cover, small
10 447 150	Eyecups for eyepieces for eyeglass wearers (1 pair)
10 446 324	Optics protective glass

Stands	
Swing arm stand	
Max. extension	560mm
Dimensions of the base	230 × 266mm
Grounding point	∅ 4.2mm
Flex arm stand	
Max. extension	995mm
Dimensions of the table clamp	105 × 100mm
Table thickness	Up to 100mm

Optical Data			
Zoom position	Total magnification	Object field in mm	Depth of field* in mm
0.5	5	46	13.62
0.63	6.3	36.5	9.03
0.8	8	28.8	5.89
1.0	10	23	3.96
1.25	12.5	18.4	2.66
1.6	16	14.4	1.71
2.0	20	11.5	1.15
2.5	25	9.2	0.76
3.0	30	7.7	0.54

* according to Berek

“With the user, for the user”

Leica Microsystems

Leica Microsystems operates globally in four divisions, where we rank with the market leaders.

• Life Science Division

The Leica Microsystems Life Science Division supports the imaging needs of the scientific community with advanced innovation and technical expertise for the visualization, measurement, and analysis of microstructures. Our strong focus on understanding scientific applications puts Leica Microsystems' customers at the leading edge of science.

• Industry Division

The Leica Microsystems Industry Division's focus is to support customers' pursuit of the highest quality end result. Leica Microsystems provide the best and most innovative imaging systems to see, measure, and analyze the microstructures in routine and research industrial applications, materials science, quality control, forensic science investigation, and educational applications.

• Biosystems Division

The Leica Microsystems Biosystems Division brings histopathology labs and researchers the highest-quality, most comprehensive product range. From patient to pathologist, the range includes the ideal product for each histology step and high-productivity workflow solutions for the entire lab. With complete histology systems featuring innovative automation and Novocastra™ reagents, Leica Microsystems creates better patient care through rapid turnaround, diagnostic confidence, and close customer collaboration.

• Medical Division

The Leica Microsystems Medical Division's focus is to partner with and support surgeons and their care of patients with the highest-quality, most innovative surgical microscope technology today and into the future.

The statement by Ernst Leitz in 1907, “with the user, for the user,” describes the fruitful collaboration with end users and driving force of innovation at Leica Microsystems. We have developed five brand values to live up to this tradition: Pioneering, High-end Quality, Team Spirit, Dedication to Science, and Continuous Improvement. For us, living up to these values means: **Living up to Life.**

Active worldwide

Australia:	North Ryde	Tel. +61 2 8870 3500	Fax +61 2 9878 1055
Austria:	Vienna	Tel. +43 1 486 80 50 0	Fax +43 1 486 80 50 30
Belgium:	Groot Bijgaarden	Tel. +32 2 790 98 50	Fax +32 2 790 98 68
Canada:	Richmond Hill/Ontario	Tel. +1 905 762 2000	Fax +1 905 762 8937
Denmark:	Ballerup	Tel. +45 4454 0101	Fax +45 4454 0111
France:	Nanterre Cedex	Tel. +33 811 000 664	Fax +33 1 56 05 23 23
Germany:	Wetzlar	Tel. +49 64 41 29 40 00	Fax +49 64 41 29 41 55
Italy:	Milan	Tel. +39 02 574 861	Fax +39 02 574 03392
Japan:	Tokyo	Tel. +81 3 5421 2800	Fax +81 3 5421 2896
Korea:	Seoul	Tel. +82 2 514 65 43	Fax +82 2 514 65 48
Netherlands:	Rijswijk	Tel. +31 70 4132 100	Fax +31 70 4132 109
People's Rep. of China:	Hong Kong	Tel. +852 2564 6699	Fax +852 2564 4163
Portugal:	Lisbon	Tel. +351 21 388 9112	Fax +351 21 385 4668
Singapore		Tel. +65 6779 7823	Fax +65 6773 0628
Spain:	Barcelona	Tel. +34 93 494 95 30	Fax +34 93 494 95 32
Sweden:	Kista	Tel. +46 8 625 45 45	Fax +46 8 625 45 10
Switzerland:	Heerbrugg	Tel. +41 71 726 34 34	Fax +41 71 726 34 44
United Kingdom:	Milton Keynes	Tel. +44 1908 246 246	Fax +44 1908 609 992
USA:	Bannockburn/Illinois	Tel. +1 847 405 0123	Fax +1 847 405 0164

and representatives in more than 100 countries

In accordance with the ISO 9001 certificate, Leica Microsystems (Switzerland) Ltd, Industry Division, has at its disposal a management system that meets the requirements of the international standard for quality management. In addition, production meets the requirements of the international standard ISO 14001 for environmental management.