

ValuTest-L

Manual Test Stand

- 110lbf (500N) capacity
- easy-to-use
- quick-acting lever
- economical solution
- compact and portable
- rugged and reliable



Shown with CFG+ digital force gauge
(Can also be supplied with BFG digital force gauge)



Tensile testing

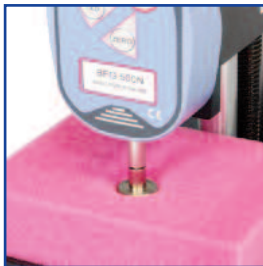

Compressive testing



Aerosol actuation



Tool testing

The ValuTest-L, combined with a Mecmesin Basic Force Gauge (BFG) or Compact Force Gauge+ (CFG+), is a simple and low cost solution for repetitive tensile and compressive testing in the production area or in laboratories. It is ideal for simple pull-off tests, push-in and push-out tests where quick comparative checks are required.

It is an accurate, precise and dependable instrument for use when simplicity, economy and fast throughput are important.

The ValuTest-L is very easy-to-use by virtue of its quick-acting lever. Crosshead movement can be limited by an adjustable stop to ensure it travels to the same position for each test.

versatile
economical
easy-to-use

Stand / Force Gauge Combinations

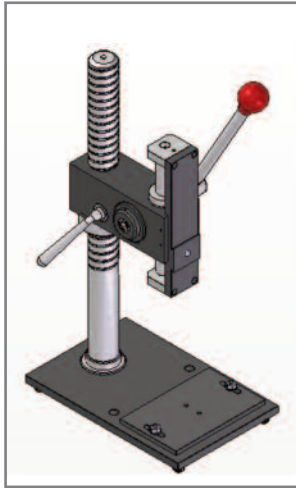

ValuTest-L

+



Basic Force Gauge (BFG)

+



BFG Bracket

or

+



Compact Force Gauge+ (CFG+)

+



CFG+ Bracket

Specifications

Daylight with BFG without accessories	13.1" (332mm)
Daylight with CFG+ without accessories	13.9" (352mm)
Effective travel without gage and accessories	6.7" (170mm)
Maximum stroke	1.9" (47mm)
Maximum load	110lbf, 500N, 50kgf
Weight	20lbs (9.2kg)
Throat depth with BFG fitted (x)	5.3" (133.5mm)
Throat depth with CFG+ fitted (x)	5.0" (126mm)

Dimensions

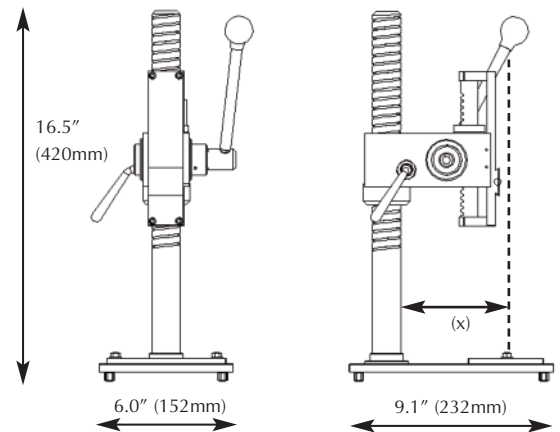

DISTRIBUTOR STAMP

Head Office

Mecmesin Limited
 Newton House,
 Spring Copse Business Park,
 Slinfold, West Sussex,
 RH13 0SZ, United Kingdom.
 e. sales@mecmesin.com
 t. +44 (0) 1403 799979
 f. +44 (0) 1403 799975

North America

Mecmesin Corporation
 45921 Maries Road,
 Suite 120, Sterling
 Virginia 20166,
 U.S.A.
 e. info@mecmesincorp.com
 t. +1 703 433 9247
 f. +1 703 444 9860

Asia

Mecmesin Asia Co. Ltd
 9/11 Chaiyo Building, 11th Floor,
 Room 1106, Rama 9 Road,
 Huaykwang, Bangkok, 10310,
 Thailand.
 e. sales@mecmesinasia.com
 t. +66 2 247 46 81
 f. +66 2 247 46 82

China

Mecmesin (Shanghai) Pte Ltd
 Room 302, No. 172,
 Daxue Lu - University Avenue,
 Yangpu District, Shanghai, 200433,
 People's Republic of China.
 e. sales@mecmesin-china.com
 t. +86 21 5566 1037 / 3377 1733
 f. +86 21 5566 1057