



Ultrasonics.Steam.Ultraclean.

Operating Instructions



Elmasteam 8 • basic • med

High-performance steam cleaner



• English •

Contents

1	General points	4
2	Important Safety Instructions	4
2.1	How to use this guide	5
2.2	Description of the warning information on the device	5
2.3	Important Information for Utilising the Device	8
2.4	Information when Utilising as a Medical Device.....	13
3	Product Description	15
3.1	Scope of Supply and Equipment	15
3.1.1	Elmasteam 8 • basic • med	15
3.1.2	Device Overview.....	16
3.2	CE Conformity Declaration.....	17
3.3	Operational Method.....	17
3.4	TECHNICAL DATA	18
3.5	Safety Equipment and Devices	19
3.6	Product Description.....	20
3.6.1	Elements on the Device Front Side.....	20
3.6.2	Elements on the Device Rear Side	21
3.6.3	Operating Displays	22
3.6.4	Saturated Steam wet/dry (optional).....	23
3.6.5	Programme Selection	24
3.6.6	Handpiece (optional).....	25
3.6.7	Luer-Lock-Connection (med)	26
3.6.8	Fixed Nozzle (optional)	27
4	Commissioning.....	28
4.1	Installation and Connection Conditions	28
4.1.1	Assembling the Mains Supply Cable.....	29
4.2	Assembling the Fixed Nozzle (Option)	30
4.2.1	Assembling the Foot Switch (option).....	32
4.3	Assembling the Compressed Air (option)	34
4.4	Assembling the Fixed-Water Connection (Option device with pump).....	35
4.5	Assembling the Water Connection to the Canister (Option device with pump)	38
4.6	Switching on the Device	41
5	Description of the Operating Displays.....	42
6	Device filling/emptying.....	47
6.1	Requirements for the Water Quality	49
6.1.1	Determining the Water Quality	49
6.2	Manual Filling.....	50
6.3	Automatic Filling with Pump (optional).....	53
6.3.1	Filling with Fixed-water Connection (option).....	54

6.3.2	Initial Filling with the Canister (option).....	55
6.4	Draining the Device.....	56
7	Handling in Operation.....	58
7.1	Working with the Handpiece.....	61
7.2	Working with the Fixed Nozzle	63
7.3	Operation with Saturated Steam wet/dry (option for device with pump).....	66
7.4	Programme Selection.....	67
7.4.1	Selecting the Steam Outlet	68
7.4.2	Selecting Soft	69
7.4.3	Selecting strong.....	70
7.4.4	Selecting lock	71
7.4.5	Service (Descaling).....	72
7.4.6	Settings	78
8	Safety / Maintenance / Repair Works	82
8.1	Regular Visual Controls.....	82
8.1.1	Cleaning the Sieve in the Water Connection.....	82
8.1.2	Cleaning the unit.....	83
8.1.3	Disinfect nozzle and entire hand-piece	83
8.2	Wear and Tear Parts.....	84
8.2.1	O-ring in the Pressure Vessel Screw Cap.....	84
8.2.2	O-ring Nozzle.....	84
8.2.3	Seal on the Collecting Tray.....	84
8.2.4	Hose (handpiece)	84
8.3	Safety Valve.....	85
8.3.1	Inspect biannually	85
8.3.2	Replacement every 3 years	86
8.4	Repair Works	87
8.5	Preparing the Device for Shipping.....	88
8.6	Troubleshooting	89
9	Decommissioning and Disposal.....	92
10	Manufacturer´s Address / Contact Address	92

1 General points

This operating manual is an integral part of the scope of delivery. It must be retained close to the device and provided with resale of device on the device.

We retain the right to implement amendments and/or alterations through technical advancements compared to the illustrated design in this operating manual without prior notice.

An operating manual cannot cover all conceivable applications. Please contact your dealer or the manufacturer for more information or for problems that are not covered in this operating manual which are, or not, of a sufficient manner.

2 Important Safety Instructions

Must be adhered to before commissioning

	INFORMATION
	<p>Please read these instructions carefully before use and only operate this electrical device in accordance with the hereby entered instructions and information.</p> <p>Note additionally the instructions of this operating manual with regard to the country-specific safety regulations.</p>

Disclaimer

	INFORMATION
	<p>No liability is assumed by the manufacturer for damage to people, equipment, devices or cleaning goods which are caused by improper use contrary to the information in this operating manual.</p> <p>The operator and/or owner is responsible for the training of the operating personnel.</p>

2.1

How to use this guide

Please read these instructions carefully before use and only operate this electrical device in accordance with the hereby entered instructions and information.

Labels and symbols in these instructions



This symbol warns of a risk of injury caused by electricity.



This symbol warns of a risk of personal injury from hot surfaces and liquids.



This symbol warns of risk of injury from hot liquids and vapours.



This symbol warns against general risks of injury and/or property damage.



This symbol warns of a risk of damage to property and indicates additional information.

Signal words in these instructions

DANGER The signal word danger warns of serious injury or death.

WARNING The signal word warning warns of serious injury.

CAREFUL The signal word caution warns of minor to moderate injuries.

INFORMATION The signal word information warns of material damage and indicates additional information.

2.2

Description of the warning information on the device



WARNING

High pressure jets!

Injuries caused by scalding!

- Never direct the jet at people, live electrical equipment or at the device itself!



WARNING

Hot vapours/hot liquids

Risk of scalding from steam!



- Only open the pressure vessel screw cap when the device is depressurised!
- Allow the pressure vessel to cool down before opening the pressure vessel screw cap!
- Observe the gauge display (Chapter 3.6.3D)! The device remains under pressure as long as one segment is illuminated on the value scale on the gauge.
- Only fill with potable water or distilled (DI)! (Descaling as an exception)



CAREFUL

Hot surface areas/hot vapours

Injuries caused by burns or scalding!

- Never reach into the area of the upper vents as they can heat up during operation!
- The ventilation slots in the area of the safety valve can become hot after triggering by escaping steam!
- Always wear suitable PPE (e.g. protective gloves, protective footwear, protective clothing)
- Place the device in the lock position during application 
- The device automatically switches off after expiry of the set  time limit.

air min. 4bar
max. 6bar

INFORMATION

Parts in the device can be damaged!

The connected compressed air must not exceed or fall under a pressure range of 4–6 bar.

(Applies only to devices with optional compressed air inlet)

Water
min. 1.6 bar
max. 6 bar
max. 20°C

INFORMATION

Parts in the device can be damaged!

The connected water pipe system must not exceed the maximum water pressure of 6 bar is not exceeded and the minimum water pressure of 1.6 bar not fall below.

The connected water pipe system must not exceed the maximum temperature of 20 °C.

(Applies only to units with optional water pump)



INFORMATION

USB port for servicing purposes



INFORMATION

Refer to the Operating Instructions

- Read the operating instructions completely before you commence working with the device.
- Failure to observe these operating instructions can cause serious injury or damage to the device.
- Always retain the operating instructions in the vicinity of the device.
- The operating manual is part of the device. Always transfer the operating instructions with the device when you pass the device on to third parties.

2.3

Important Information for Utilising the Device

Always implement the device according to the operating instructions. No liability can be assumed by the manufacturer for the safety of people, as well as the functionality of the device, caused from improper use of the device.

Intended Use This steam cleaner is intended exclusively for cleaning objects. Living creatures must never be subjected to steam jets! Application is only permitted in commercial areas!

When utilised as a medical product, please refer to the additional information in *Chapter 2.4*.

Warranty 3 years warranty when utilised for the intended use:

Actuations manual unit/foot switch: 37500 Units

Steam time: 500 h (saturated steam)

Standby time: 6000 h

Heating time: 900 h

Operating Personnel For security and/or safety reasons, only qualified personnel who are authorised and familiar with the operating instructions of this steam cleaner may operate this steam cleaner. Unauthorised personnel, especially children, must never operate this device.

People with active implants Elma Schmidbauer products with the CE mark comply with the European EMC and Low Voltage Directive and adhere to the prescribed EMC limit values so that the electromagnetic radiation emitted by the devices is harmless to healthy people. A binding statement for people with implants, such as those with cardiac pacemakers or implanted defibrillators, can only be made at the specific occupational site and upon consulting the manufacturer of the implants.

Inspect for possible transport damage Inspect the device after unpacking for possible transport damage. Never commission the device when visible damage is identified. Always contact the supplier and transport company in such cases.

Installation Position the device on a stable, level, dry surface which is insensitive to moisture. The ventilation slits must never be covered. Ensure that the workplace is sufficiently ventilated!

Mains Supply Connection The device must only be connected to a properly grounded connection socket to comply with the safety regulations.. The technical specifications on the nameplate must correspond with the available connecting conditions. In particular, the mains supply voltage and current connected load.

Prevention of Electrical Accidents

To prevent electrical accidents, and damage to the device, the device must never be subjected to steam jets or liquid penetration.

Always unplug the mains supply connection with damage to the device or ingress of moisture.

The device may only be opened by authorised personnel. Unplug the mains supply connection before opening the device.

Do not operate the device when a mains supply cable or other important parts of the device are damaged e.g. safety elements or steam nozzles.

The plug and coupling must be watertight when an extension cable is utilised. Warning: Unsuitable extension cables can be dangerous.

Filling

Only fill the device with potable water or DI water.

No chemical additives

Do not use any chemical additives. Only operate the device with potable water or DI water. Descaling as an exception (Chapter 6.4.5).

Descaling Resources

Only utilise pure citric acid (45 g = 3 tablespoons of pure citric acid dissolved in 1.5 litres of water) for descaling. Misuse can cause damage e.g. on the pressure vessel seal.

Maintenance and Repair

Follow the instructions for maintenance works as described in these operating instructions at regular intervals (Chapter 8) to ensure the functionality and safety of the device.

Repair works must only be executed by authorised Elma professionals and service centres. Disconnect the power supply connection before commencing maintenance works or opening the device.

Original parts must be utilised for repair works or any accessories.

Devices with Fixed Water Connection

Always close the water supply to the pump on the stopcock after operation or when the device is left unattended.

Devices with Compressed Air Connection

Only utilise clean air. Do not use compressed air which includes chemicals, synthetic oils containing organic solvents, salt or corrosive gases etc. as this may cause damage or malfunctions on the device.

- Install an air filter close to the valve on the upstream side. Select a filtration degree of maximum 5µm. Remove excessive carbon dust by installing a micro-filter on the upstream side of the valve. If excessive carbon dust is generated by the compressor, then this may adhere in the valve and cause a malfunction.
- Fit a check valve to the on-site compressed air feed to prevent any damage to this feed in the event of a fault. We recommend checking the check valve yearly to ensure it functions correctly and to replace it if necessary.

Cleaning Result	<p>Maximum compressed air temperature: 40 °C Do not exceed the stated maximum air pressure as this may result in personal injury and increased material wear and tear.</p> <p>The user is responsible for the control of the cleaning result.</p>
Upright Transport	<p>The device must be stored and transported upright when the pressure vessel is full as otherwise residues can clog the steam valve and steam pipes.</p>
Storage and Transport Conditions	<p>Care must be taken to prevent damage during storage and transportation of the device. Basically, storage or transportation at temperatures below the freezing point must be avoided. Freezing water in the steam cleaning device can impair the function sustainably. Drain the unit completely before storing or transporting.</p> <p><i>Temperature during storage: +5 °C (+ 41 °F) to + 40 °C (+ 104 °F)</i> <i>Temperature during transport: -15 °C (+ 5 °F) to +60 °C (+ 122 °F)</i> <i>Humidity and air pressure during storage and transport:</i> <i>10 % - 80 % relative humidity; not condensing</i> <i>Pressure range 500 hPa - 1060 hPa absolute</i></p>
Disclaimer	<p>Elma Schmidbauer GmbH will reject all claims for damages or warranty claims when:</p> <ul style="list-style-type: none"> • The product is utilised in any way for other than that intended use as referred to in this manual. • When unauthorised technical modifications, amendments and alterations have been made to the product by third parties. • The product was not repaired at a service centre authorised by the manufacturer or was repaired without using original spare parts. • The product was utilised used despite obvious safety faults or damage being recognisable on the device. • External forces • The prescribed maintenance works have not been conducted.



**High Temperatures
Nozzle**

	<p style="background-color: #f4a460; margin: 0; padding: 5px;">WARNING</p> <p>High temperatures on the nozzle with nozzle tube! Serious injuries from burns!</p> <ul style="list-style-type: none"> • Only touch the said areas with personal protective equipment (e.g. protective gloves). • Allow the unit to cool down before touching any part thereof.
-------------------------------------------------------------------------------------	-------------------------------------------------------------------------------------------------------------------------------------------------------------------------------------------------------------------------------------------------------------------------------------------------------------------------------------------------------------------------------------------------------------------------

**Pressure Vessel
Screw Cap**

	WARNING
	<p>Hot vapours/hot liquids</p> <p>Risk of scalding from open pressure vessel screw cap</p> <ul style="list-style-type: none"> • Hot water splashes and evaporates from the filling opening • Turn off the device immediately using the mains supply switch, unplug the mains supply cable from the power supply or set the programme selection to steam outlet (Chapter 6.4.1) • Let the appliance cool down • Only close the pressure tank screw cap once the unit has cooled down.

**Hot steam when
triggering the safety
pressure valve**

	CAREFUL
	<p>Hot steam! Steam will escape from the ventilation openings for a short time with a possible triggering of the safety valve.</p> <p>Risk of scalding!</p> <ul style="list-style-type: none"> • Unplug the mains supply plug. • Place the device in the  lock position during application breaks. • Keep unauthorised persons away from the device. • Securely fix the manual unit in the programme steam outlet. • Ensure that the escaping steam will not endanger people, fixtures or equipment.

Noise Emission

	CAREFUL
	<p>Noise Emission!</p> <p>Steam cleaning devices can cause annoying sounds during operation.</p> <ul style="list-style-type: none"> • Always wear personal ear and hearing protection equipment during the stay in the workspace.

**Electrostatic
discharge**



INFORMATION

The outflow of steam at high velocity causes electrostatic charge generated by friction to accumulate on the nozzle as well as on the product to be cleaned. The electrostatic charge developed on the handpiece is continuously dissipated via the ground connection of the device. Depending on external conditions such as insufficient conductivity of the floor and/or shoes, dissipation of electrostatic charge of the product to be cleaned may be impaired.

Although harmless to healthy people, this occurrence is unpleasant and can result in a tingling sensation or an electric shock, similar to the effect created on carpeted floors or from velour seats in cars. The discharge generated can be observed as a visible spark from the cleaned object to the hand-piece.

- It is recommended in such cases to ground the product to be cleaned or, if necessary, the wrist of the user (e.g. with an ESD wrist strap).
- single-use ESD (antistatic) gloves should be used.

2.4

Information when Utilising as a Medical Device

Intended Use

The products of the Elmasteam 8 med Series are intended for cleaning hard to reach areas on medical instruments. This cleaning is NOT a replacement for the subsequent cleaning, disinfection or sterilisation in automated standard processes (e.g. RDG or autoclave).

The device is particularly suitable for the cleaning of:

- Joint areas of joint instruments
- Fluted surfaces of e.g. forceps
- Cleaning of melted fabric material on electro-surgical instruments (e.g. bipolar forceps)
- Cleaning of drills and cutters (drilling/milling heads with e.g. residual tissue, bone meal)
- Pre-cleaning of the lumen of hollow instruments.

The utilisation of Elmasteam has to be previously clarified with the instrument manufacturer for temperature-sensitive instruments. (Steam temperature *Chapter 3.4 Technical Data*)

The plastic-coated portion of the instrument must not be processed with the device (risk of detachment) when pre-cleaning of instruments made of composite material (e.g. steel-plastic in bipolar forceps).

Intended Use

Steam cleaner for manual pre-cleaning or treatment of instruments.

Only medical devices that are approved and reusable for reprocessing must be cleaned (refer to the information from the medical device manufacturer in accordance with EN ISO 17664). The operation must only be performed by trained personnel and not by children. Operating and equipment must be executed in accordance with the conditions and the media defined in the operating instructions. The service intervals as well as regional regulations for inspecting the device must be adhered to.

Disinfect the Instruments before Cleaning

Instruments must be disinfected in accordance with the instructions from the instrument manufacturer prior to processing and treating with the device e.g. as in disinfectant solution according to the VAH list.

**Safety Precautions
for the User**

INFORMATION

Safety Precautions for the User!

The exact adherence to all safety regulations must be observed, in particular the wearing of suitable protective clothing (jacket, cap, heat resistant gloves, a mask and face shield (visor)).

**Generation of
Aerosols**

WARNING



Generation of Aerosols!

Transmission of pathogens!

- For protection of the personnel in the area of instrument cleaning, a suitable suction device and drip device are strongly recommended. (e.g. Elma steam workplace with autonomous suction and Hepa Filter).
- Wear a suitable mouth protection.

3 Product Description

3.1 Scope of Supply and Equipment

3.1.1 Elmasteam 8 • basic • med

- 1 Basic Device with 5 litres of tank volume
- 1 Maintenance Hose
- 1 Mains Supply Cable
- 1 Filling Sieve
- 1 Flushing Set
- 3 O-rings for pressure vessel screw cap
- 1 Water Hose (fixed-water supply)
- 1 fixed nozzle with a 1.8 mm diameter (optional)
- 1 catheter attachment (med.)
- 1 Luer lock adaptor female/female (med.)
- 2 test strips to determine water hardness
- 2 test strips to determine chloride content
- 1 Set of Operating Instructions
- 1 Information Data Sheet for Water Quality
- 1 Information Data Sheet for the Warranty Conditions

Accessories:

- 1 canister with hose, ventilation and level monitoring
- Fixed nozzle (with 2 mm nozzle diameter)
- Manual Unit with hose 2.3m
- Evaporating Bowl
- 8-piece adapter set for Luer-Lock-connection (med)

3.1.2 Device Overview

	DL Compressed Air	FD Fixed Nozzle	HS Hand piece (1,4 m)	HSL Hand piece (2,3 m)	ND Saturated Steam	P Pump		MED Design with Luer Lock
Elmasteam 8 basic								
FD		O						
FD-DL	O	O						
HS			O					
HS-DL	O		O					
HS-FD		O	O					
HS-FD-DL	O	O	O					
P-FD		O				O		
P-FD-DL	O	O				O		
P-HS			O			O		
P-HS-DL	O		O			O		
P-HS-DL-ND	O		O		O	O		
P-HS-FD		O	O			O		
P-HS-FD-DL	O	O	O			O		
P-HSL				O		O		
P-HSL-DL	O			O		O		
Elmasteam 8 med								
HS	O		O					O
HS-DL	O		O					O
P-HS-DL	O		O			O		O
P-HSL-DL	O			O		O		O

Table 3.1.2 Device Overview

3.2 CE Conformity Declaration

This steam cleaning device fulfils the CE marking criteria and EU directives:

- 2014/35/EU Low-voltage Directive
- 2014/30 / EU EMC Directive
- 93/42 / EEC Medical Device Directive
- 2011/65 / EC RoHS Directive

The declaration of conformity can be requested from the manufacturer.

3.3 Operational Method

Generating Pressure	Water is heated by a heater to 185 °C in a manually or automatically filled pressure vessel, A steam pressure of maximum 8 bar is thereby generated.
Steam Outlet	The steam is provided through the nozzle(s) for availability.
Saturated Steam	Steam and hot water are thereby mixed from the pressure vessel. (Optional) The mixing ratio can be adjusted via the rotary knob for wet/dry.
Operating Resources	Operate the device exclusively with potable water or DI water. The conductivity of the water must be at least 2 µS / cm.

3.4

TECHNICAL DATA

	Elmasteam 8
Mains voltage (Vac)	220 - 240
Mains frequency (Hz)	50 / 60
Mains Supply Connection	Shockproof safety plug 1 phase
Mains impedance maximum (Ohm)	0.155
Power consumption maximum (W)	3120
Sound pressure level at 8 bar dBA)	93
Pressure in the pressure vessel (bar)	8
Pressure vessel volumes (litres)	5
Maximum filling volume (litres)	3.8
* Heating up time (minutes)	20
Steam temperature outlet	Approximately 160 °C
Steam temperature in the boiler	Approximately 185 °C
Dimensions without manual unit bracket and fixed nozzle W x D x H (mm)	285 x 350 x 520
Material housing	Stainless steel
Pressure vessel	Stainless steel / aluminium bronze
Weight (kg)	Approximately 20

** Guide value for maximum-filled pressure vessel and 8 bar pressure*

3.5

Safety Equipment and Devices

The devices are equipped with all prescribed safety devices and/or equipment such as e.g.:

- Safety pressure relief valve
- Safety pressure vessel closure for inadmissible opening of the pressure vessel screw on the filler pipe.
- Low voltage in handpiece

3.6 Product Description

3.6.1 Elements on the Device Front Side

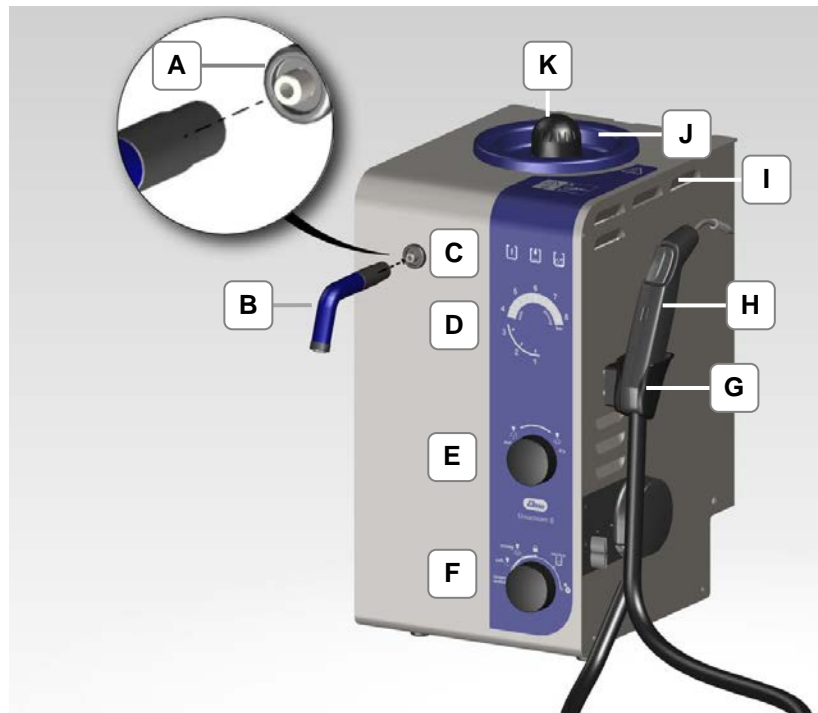

Figure 3.6.1.1: View of the device, front side

- A Connection** For attaching the fixed nozzle (optional)
- B Fixed Nozzle** (optional)
- C Operating Displays** Warning/Filling Level/Service
- D Gauge** Indicator 1 - 8 bar /Service Mode (Level indicator 1 - 8)
- E Rotary knob** wet/dry (Setting the mixing ratio). Refer to Chapter 6.3 for a description
- F Rotary knob** for programme selection: Turn the rotary knob to select the function and press the rotary knob to confirm the selection. Refer to Chapter 6.4 for a description
- G Bracket** For handpiece (optional)
- H Handpiece** (optional)
- I Ventilation Openings** (lateral on the housing)
- J Drip Tray** (Manual filling) for overflowing water
- K Pressure Vessel Screw Cap:** Filling opening for manual filling. Screw to open in an anti-clockwise direction.

3.6.2 Elements on the Device Rear Side

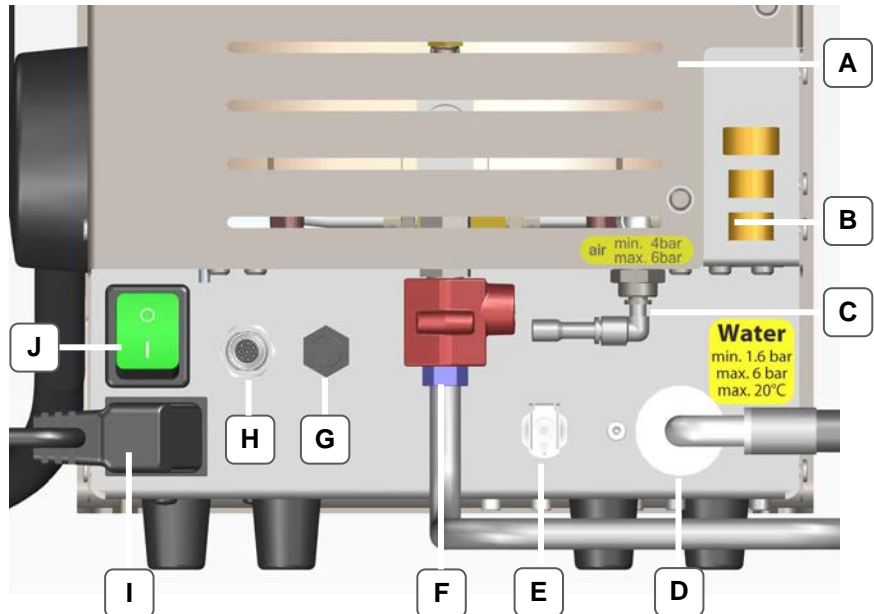



Figure 3.6.2.1: Device, rear side

- A Ventilation Openings**
- B Safety Valve**
- C Input Connection for External Compressed Air Supply (optional)**
- D Connection for Water Supply to the Pump (optional)**
- E Connection for Exhaust Hose for the Canister (optional)**
- F Ball Valve with Protective Cover** for emptying the pressure vessel and for maintenance works.
- G Connection for Filling Level Sensor on the Canister (optional)**
- H Connection for Foot Switch for the assembled Fixed Nozzle (optional)**
- I Connection for Mains Supply Cable**
- J On/Off Switch** (Mains switch, illuminates as green in operation)

3.6.3 Operating Displays

INFORMATION	
	<p>Always observe the operating displays during operation!</p> <ul style="list-style-type: none"> • Warning (A) signals warnings (illuminates/flashes red). • Filling-level (B) signals the filling-level status (illuminates/flashes blue). • Service/Descaling (C) signals a descaling for the device (illuminates/flashes orange). • Gauge (D) signals the current pressure value (illuminates green), adjusted operating pressure (flashes green) until the pressure is achieved. • Step Display (D) for programme-controlled descaling programme.

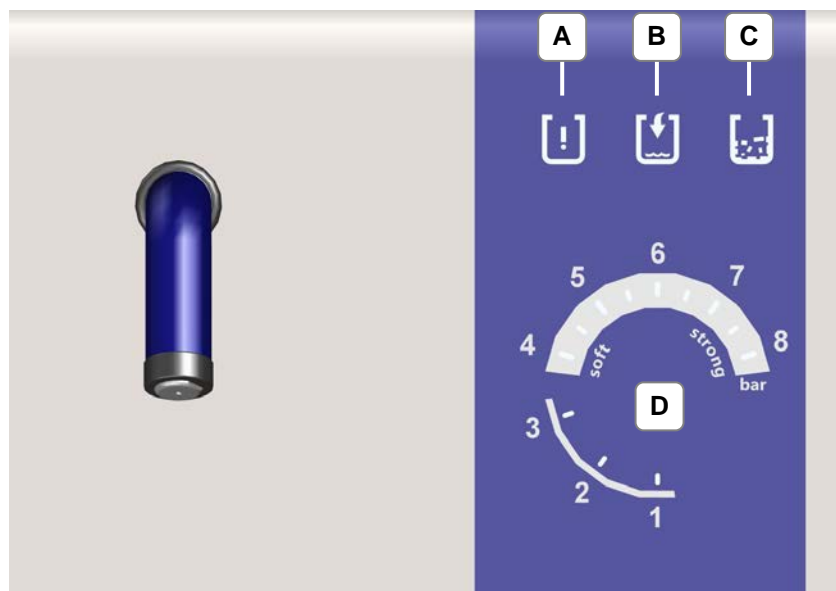

Figure 3.6.3.1: Operating Displays

- Warning (A)** Illuminates or flashes red for warnings for Filling Level/Descaling.
- Filling Level (B)** Illuminates or flashes blue to indicate the filling level status in the pressure vessel or the optional canister.
- Service/Descaling (C)** Illuminates or flashes orange to signal descaling for the device.
- Gauge (D)** Illuminates or flashes green to indicate the operating pressure, pressure value as well as the step display for the descaling programme.
- Signal Tone** Sounds for warnings, signals the urgency.

3.6.4

Saturated Steam wet/dry (optional)

	INFORMATION
	Saturated steam is available on the handpiece (Chapter 7.1 Working with the handpiece).



Figure 3.6.4.1: Rotary knob wet/dry

Wet Turn the rotary knob (A) to the end-limit "wet" = 100 % operating with saturated steam.

Dry Turn the rotary knob (A) to the end-limit "dry" = 100 % operating with dry steam.

The intensity of the mixing ratio of the steam function will be regulated by turning the rotary knob (A) as 0 – 100 %. The mixing ratio can also be adjusted during the steam operation.

3.6.5 Programme Selection



INFORMATION	
	<p>Rotary knob for programme selection.</p> <p>Simple utilisation: Turn the rotary knob to select the function and press the rotary knob to confirm the selection.</p> <p>The selected programme lights up as blue on the display segment (point).</p> <p>The device is pre-set to the factory settings (Table Chapter 7.4.6.1 Settings).</p> <p>The device automatically changes after the expiry of the set time to lock  (Figure 3.6.5.1-D).</p>



Figure 3.6.5.1: Rotary knob, programme selection

- A steam outlet** to drain the residual pressure in the pressure vessel (before opening the pressure vessel screw cap). Steam can be discharged through the handpiece or fixed nozzle (Chapter 7.4.1).
- B soft** for the pressure range 4 - 6 bar. The adjusted operating pressure on the gauge illuminates as green until the pressure has been built up/reduced. The pressure achieved illuminates as green on the gauge.
- C strong** for the pressure range 6 - 8 bar. The adjusted operating pressure on the gauge illuminates as green until the pressure has been built up/reduced. The pressure achieved illuminates as green on the gauge.

- D Lock** for application breaks. To prevent inadvertently escaping steam or compressed air. Foot switch for the fixed nozzle and the handpiece are deactivated.
- E service (descaling)** for program-controlled descaling. Follow the step indicator on the gauge (Chapter 7.4.5 Service (Descaling)).
- F Settings** for steam soft, steam strong, time to lock, time to eco, measurement value, lime content, reset the device to factory settings (Chapter 7.4.6 Settings).

3.6.6 Handpiece (optional)

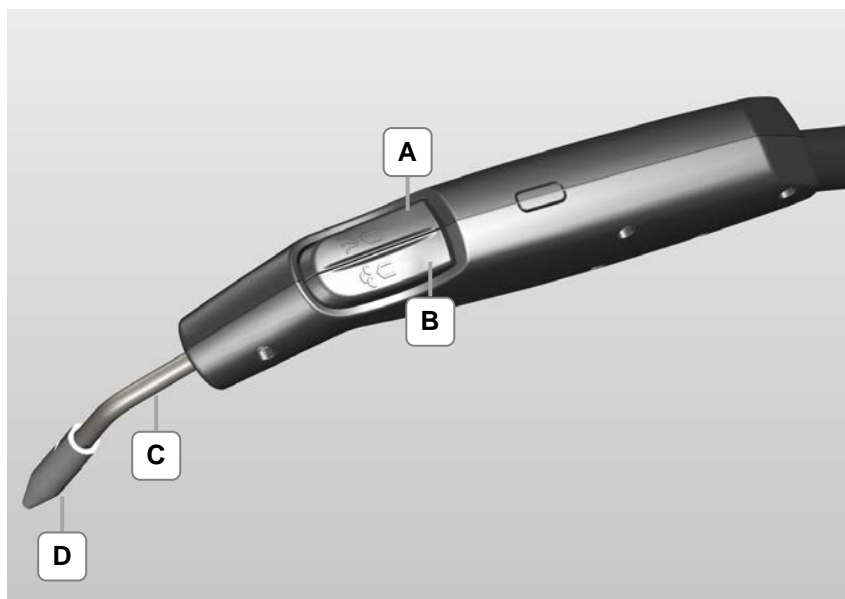

Figure 3.6.6.1: Handpiece

- A Activated Compressed Air (optional)**
- B Activated Steam**
- A+B Activated Steam** (both button pressed)
- C Nozzle Pipe**
- D Nozzle Pipe** or optional Luer-Lock connection (MED)

3.6.7

Luer-Lock-Connection (med)

INFORMATION	
	The Luer-Lock connection on the device is intended for connecting special adapters that are designed for cleaning the inside of hollow instruments. The medical adapter is included in the scope of delivery for medical devices.



Figure 3.6.7.1: Handpiece with Luer-Lock-Connection (med)

A Luer-Lock Connection (med)

3.6.8 Fixed Nozzle (optional)



INFORMATION

The steam operation with the fixed nozzle will be activated via the foot switch.



Figure 3.6.8.1: Fixed Nozzle

A Fixed Nozzle

4 Commissioning

4.1 Installation and Connection Conditions

Packaging	Retain the original packaging when possible or dispose of it professionally in accordance with applicable waste disposal regulations. You can also return the surplus packaging (at your expense) to the manufacturer.
Inspect for transport damage	Inspect the device after unpacking for possible transport damage before initial commissioning. The device must not be connected to the mains supply when damage has been identified. Always immediately contact your supplier and transport company in such cases.
Installation	Position the device on a stable, level, dry surface which is insensitive to moisture. The ventilation slits must never be covered. Retain a distance of at least 10 cm to the walls on the rear side. Ensure adequate ventilation in the workplace.
Environmental Conditions	<p>The device may only be operated:</p> <ul style="list-style-type: none"> • in well-ventilated internal areas. • at an ambient temperature of 5 °C - 40 °C [41 °F - 104 °F] *) • at a maximum relative humidity of 80 % at 31 °C [87.8 °F], decreasing linearly to 50 % relative humidity at 40 °C [104 °F] *) • With a mains power supply when the voltage fluctuations do not exceed 10 % of the nominal value. <p>*) Between 5 - 30 °C [41 - 86 °F], the device is ready for operation at a relative humidity of up to 80 %. At temperatures from 31 - 40 °C [87.8 to 104 °F], the humidity must decrease proportionally in order to ensure operational readiness (e.g., at 35 °C [95 °F] = 65 % humidity at 40 °C [104 °F] = 50 % humidity). The device must not be operated at temperatures above 40 °C [104 °F].</p>
Nameplate	Connect the device to a suitable mains supply plug socket. The technical data on the nameplate (Figure 4.1.1-A) must correspond fully with the available connecting conditions, in particular mains voltage and current connected load.

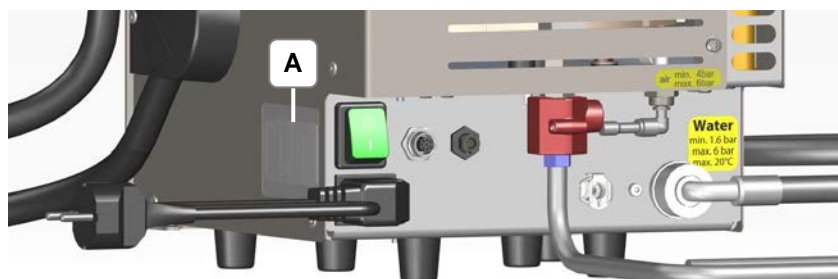



Figure 4.1.1: Nameplate (on the side of the unit)

Connecting the Device to the Mains Supply

	DANGER
	<p>Risk of electric shock! Serious injuries / death!</p> <ul style="list-style-type: none"> • Connect the device to a suitable mains supply plug socket. • The technical data on the nameplate (in particular mains voltage and current connected load) must correspond with the available connecting conditions. • Place the appliance on a dry, flat and stable surface. • Ensure adequate ventilation. • Keep the installation area and housing dry. • Steam and/or hot water outlets must never point towards the device.

4.1.1

Assembling the Mains Supply Cable

	INFORMATION
	<p>Assembling the Mains Supply Plug</p> <ul style="list-style-type: none"> • Observe the technical data on the nameplate (Figure 4.1.1.1-C)! Make sure that the electrical plug socket has the same voltage as that indicated on the nameplate. • The plug socket for the mains supply cable must be easily accessible. In an emergency, pull the mains plug out of the plug socket! • Inspect the mains supply cable for damage before using it. A damaged mains supply cable must not be used!

Assembling the Mains Supply Cable

1. Connect the mains supply cable (Figure 4.1.1.1-A) to the connector (Figure 4.1.1.1-B).
2. Plug the other end of the mains supply cable into the prescribed plug socket.

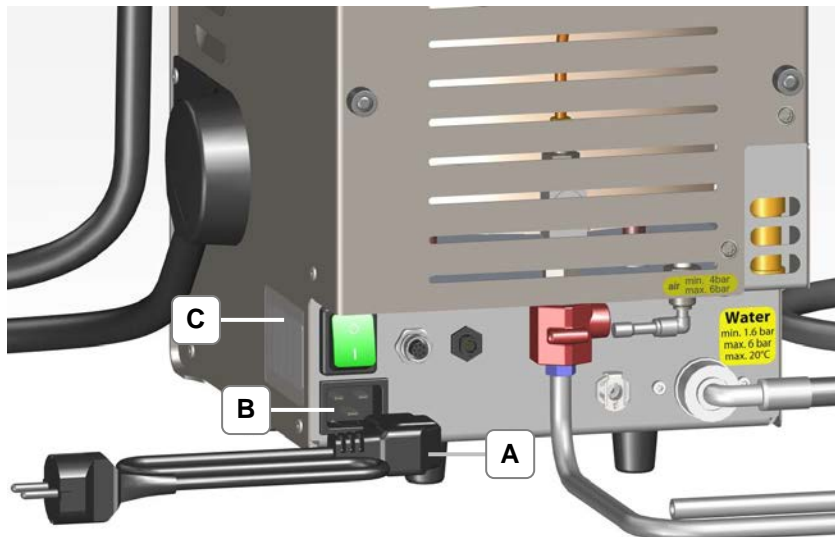



Figure 4.1.1.1: Mains Supply Cable

4.2

Assembling the Fixed Nozzle (Option)

INFORMATION	
	<p>Only assemble the fixed nozzle with switched off and depressurised devices!</p> <ul style="list-style-type: none"> • To prevent that people could be scalded by built-up pressure causing accidentally escaping steam! • Ensure that the device is switched off and depressurised.

Assembling the Fixed Nozzle

1. Remove the dummy plugs by unscrewing the nut (A) with an open-ended spanner SW 12 mm (Figure 4.2.1).
2. Screw the fixed nozzle (B) with the nut (C) by hand (hand tight) until it stops on the connecting piece (D) on the device (Figure 4.2.2).
3. Tighten the nut of the fixed nozzle with a quarter turn with an open-ended spanner SW 12 mm.
4. Inspect whether the nut is tightened and the fixed nozzle is fixed to the steam outlet downwards.
5. Slide the black protective cover in the arrow direction over the nut (Figure 4.2.3).

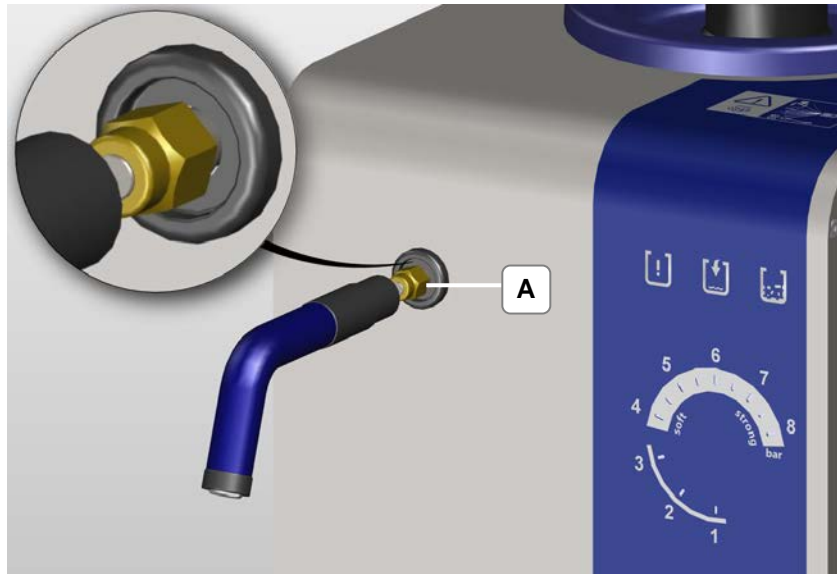

Figure 4.2.1: Union nut with dummy plugs

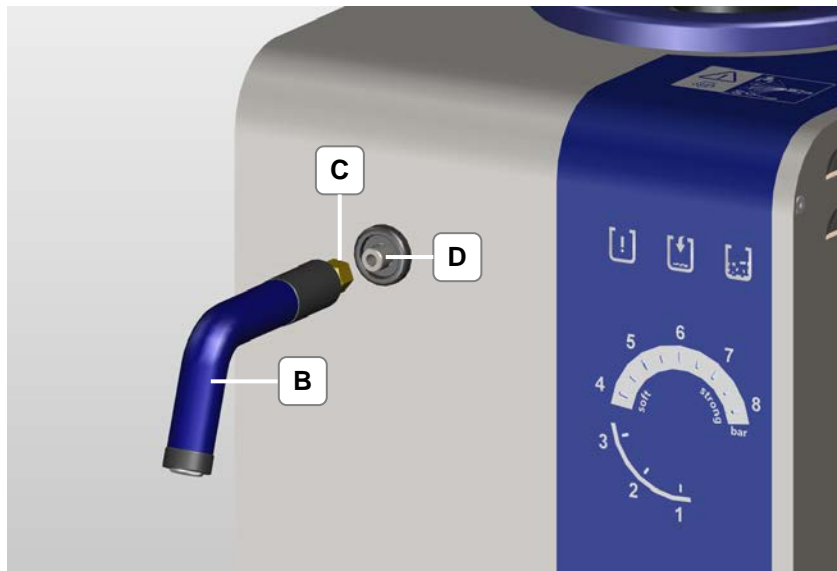

Figure 4.2.2: Screwing on the Fixed Nozzle

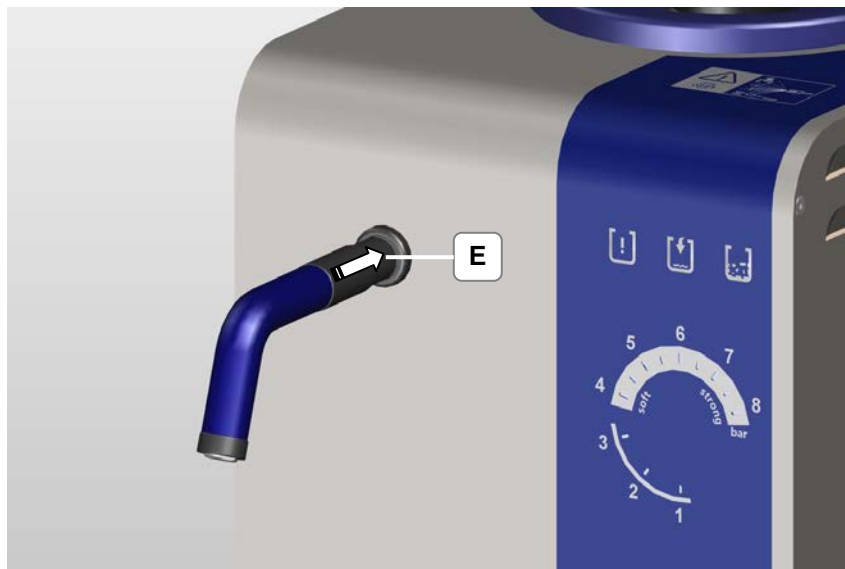

Figure 4.2.3: Pushing on the black protective cover onto the nut

4.2.1

Assembling the Foot Switch (option)

Assembling the Foot Switch

1. The plug for the foot switch will be screwed onto the connection (Figure 4.2.1.1-A).
Observe the plug direction when plugging in (Figure 4.2.1.2-B)!
The plug clicks during rotation!
Manually tighten the plug until it stops turning (Figure 4.2.1.3-C).



Figure 4.2.1.1: Connection for the Foot Switch (Rear panel)

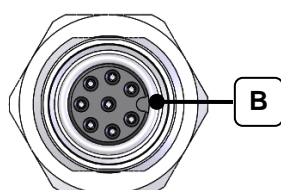

Figure 4.2.1.2: Aligning the plug (B)

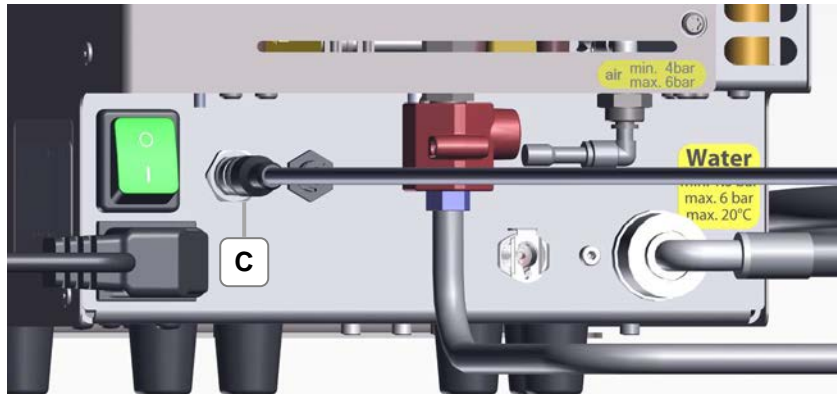

Figure 4.2.1.3: Plug for the Foot Switch (Rear side of the device)

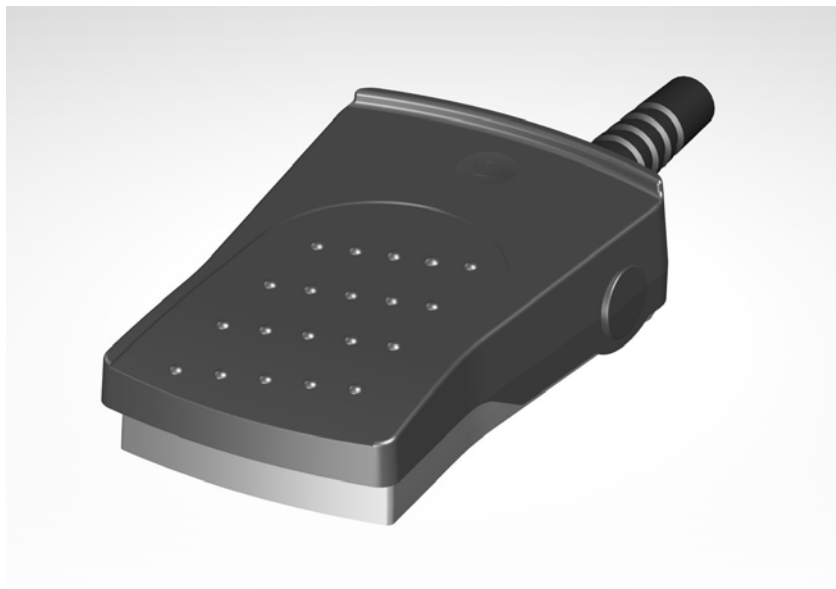



Figure 4.2.1.4: Foot Switch

4.3

Assembling the Compressed Air (option)

INFORMATION	
	<p>Only assemble the compressed air when the device is switched off!</p> <ul style="list-style-type: none"> • Connect the device to a compressed air supply with a maximum pressure of 6 bar! • The compressed air must be free from dirt particles (Chapter 2.3) • Ensure that the device is switched off.

Assembling the Compressed Air

1. Remove the blind plug (4.3.1-A). For this purpose, press the locking ring (4.3.1-B) in the arrow direction while pulling the plug (4.3.1-A) in the reverse direction.
2. Push the compressed air hose (Ø6 mm) in direction of the arrow until it stops in the angled connection screw (4.3.2-C).
3. Option: Insert the angled connection screw (4.3.1-C) to connect the compressed air hose directly into the connection. (4.3.1-D).

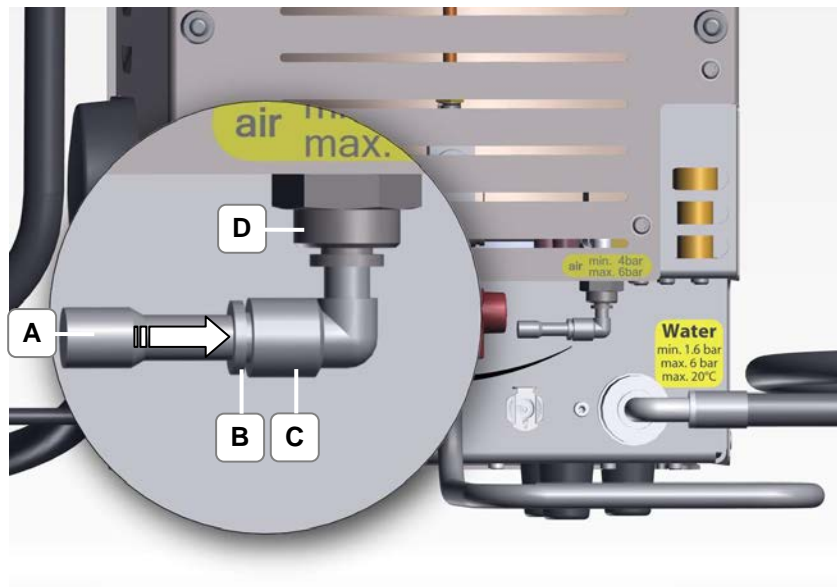



Figure 4.3.1: Blind plug for compressed air connection



Figure 4.3.2: Connection for compressed air (without blind plug)

4.4

Assembling the Fixed-Water Connection (Option device with pump)

	INFORMATION
	<p>Only assemble the fixed-water connection with switched off and depressurised devices!</p> <ul style="list-style-type: none"> • The minimum water pressure of 1.6 bar must be retained. The maximum water pressure of 6 bar must not be exceeded. Components within the device may be damaged. • Utilise the supplied water hose. If necessary, an extension hose (2 m) can be ordered as an accessory. • Ensure that the device is switched off and depressurised.
	CAREFUL
	<p>Leaking water!</p> <p>The venting hose (Fig. 4.5 3-G) must be removed if a unit with a cannister is fitted to a fixed water connection.</p> <ul style="list-style-type: none"> • Remove the venting hose, so that the cannister does not overflow

Assembling the fixed-water connection

1. Attach the flat seals (A) from the scope of delivery in the screwed threads (B + C). (Figure 4.4.1).
2. Screw on the screwed thread (Figure 4.4.1-B) of the water hose onto the water connection of the device. (Figure 4.4.2-D).
3. Screw on the screwed thread (Figure 4.4.1-C) of the water hose onto the connection for the water pipe. (Figure 4.4.3-E).



Figure 4.4.1: Water hose with flat seals (scope of delivery)



Figure 4.4.2: Device connection (D) for water supply (water pipe)



Figure 4.4.3: Connected water hose

After the assembly

INFORMATION	
	<p>Inspect the secure fixing for the fixed-water connection!</p> <ul style="list-style-type: none">• Maintain a proper and secure fixing for the water hose.• Inspect the connections (Figure 4.4.3-E + F) for tightness.

4.5

Assembling the Water Connection to the Canister (Option device with pump)

INFORMATION	
	<p>Only assemble the water connection with switched off and depressurised devices!</p> <ul style="list-style-type: none"> • Utilise the supplied accessories. (Hose, ventilation hose, cable for filling level monitoring, canister) • Ensure that the device is switched off and depressurised. • The connections (hose, ventilation hose and cable for filling level monitoring) for the canister are prepared and connected to the canister. Connect these to the device!

Assembling the Water Supply Canister

1. Screw on the screwed thread (Figure 4.5.1-A) of the water hose onto the water connection of the device (Figure 4.5.2-F). Inspect whether the seal is positioned correctly in the screwed thread (Figure 4.5.1-A).
2. Connect the cable connector (Figure 4.5.1-B) for the fill level monitoring to the connection (Figure 4.5.2-H) and turn the front cap (Figure 4.5.3-I) until it locks. Observe the plug direction (Fig 4.5.4-J).
3. Insert the ventilation hose (Figure 4.5.1-C) into the connector (Figure 4.5.2-G).

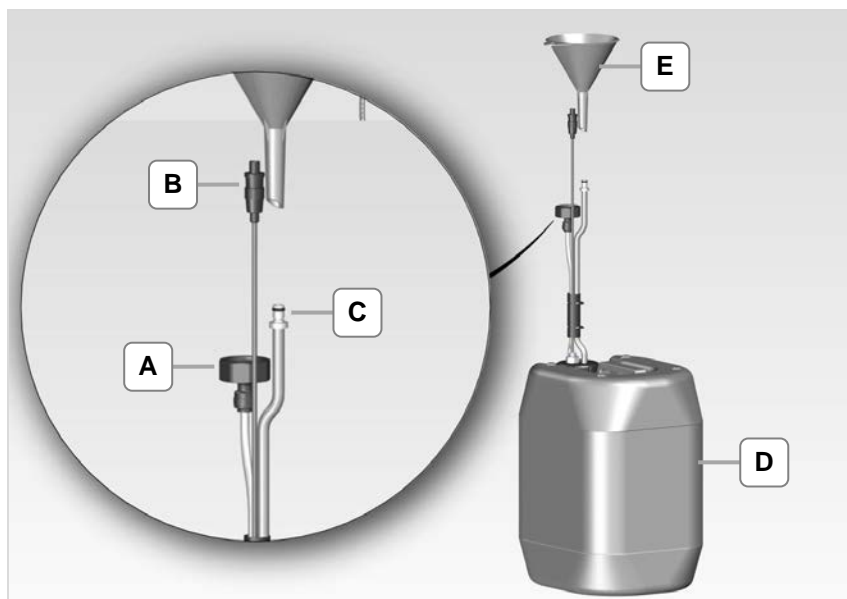

Figure 4.5.1: Canister with accessories

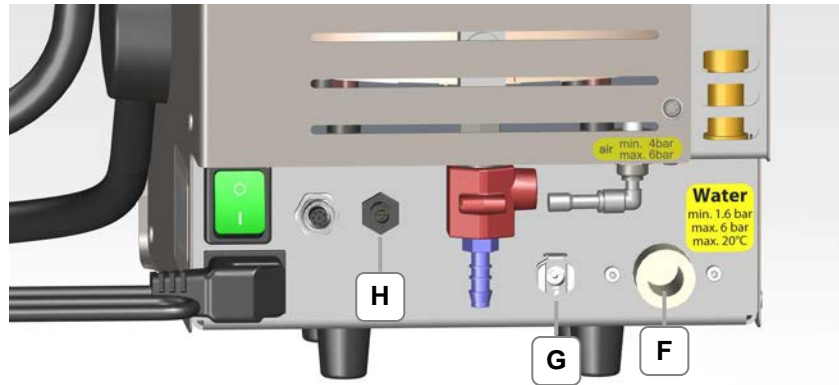

Figure 4.5.2: Connections for the canister (rear side of the device)

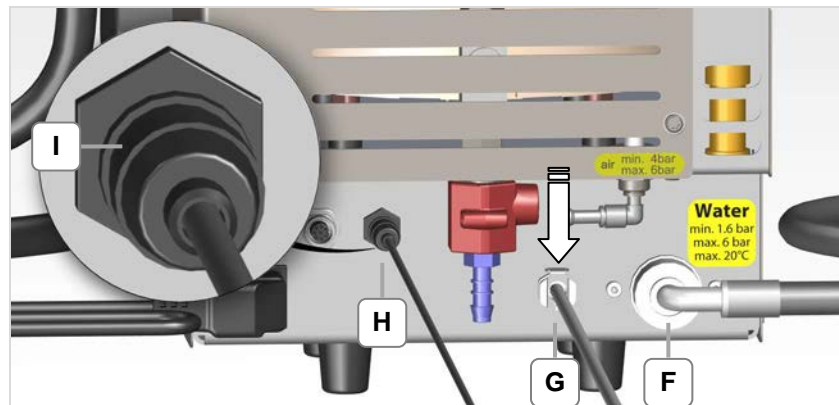

Figure 4.5.3: Connections for the canister connected

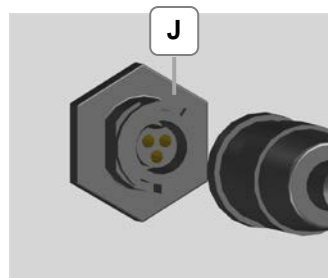

Figure 4.5.4: Plug alignment (J)

After the assembly

INFORMATION

Inspect the secure fixing of the water connection for the canister!



- Maintain a proper and secure attachment of the connections.
- Inspect the connections (Figure 4.4.3-E + F) for leak tightness and function.
- Ensure when connecting the ventilation hose that the locking lever (Fig 4.5.3-G) points downwards in the direction of the arrow!

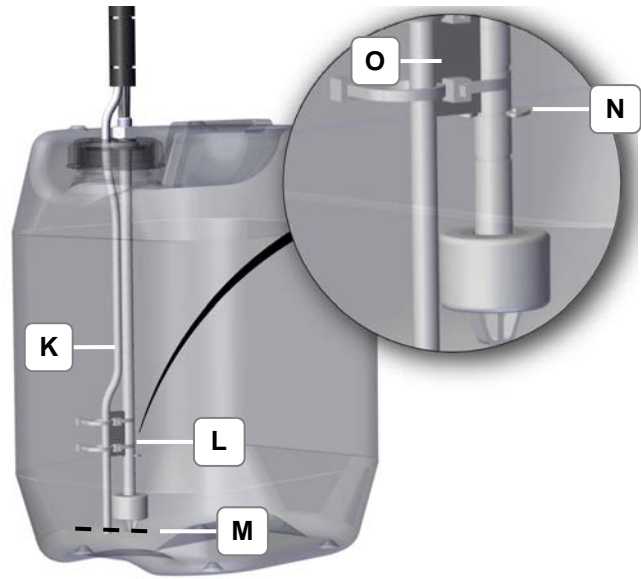



Figure 4.5.5: Water hose and cable

Level for the water connection and filling level cable

The hoses and cables in the canister are pre-assembled. It may be that these have been displaced during transport or unpacking.

Inspect hose (K) and cable (L). Align these when necessary to the same level (M) when they have been displaced.

INFORMATION	
	<p>Pump Operation</p> <ul style="list-style-type: none"> The trouble-free functioning of the pump operation is guaranteed when water hose (K) and cable (L) are set to the same level (M) (Figure 4.5.5)-

4.6 Switching on the Device

INFORMATION	
	<p>Utilise the last programme selection</p> <p>The device will start up with the last programme selection when it is switched on. When the machine has heated up, then you can implement the last programme which was utilised or switch to another programme.</p>

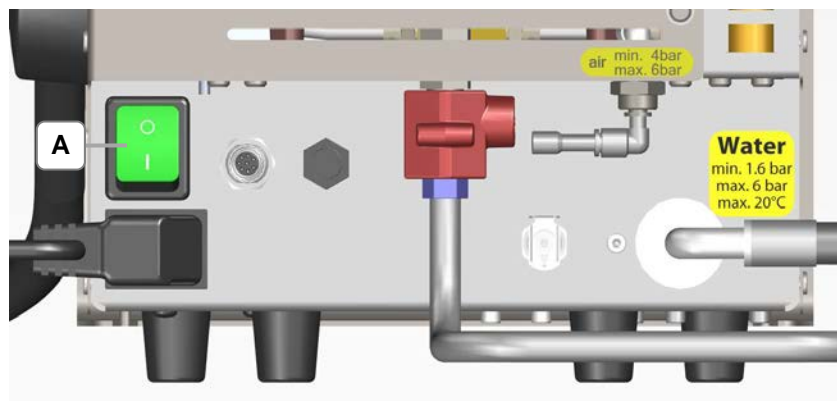

Figure 4.6.1: Device, rear side

Prerequisite The mains supply cable is plugged into the appropriate socket.
The commissioning was executed.

- Switching on the Device**
1. Switch on (I) the mains supply switch (A). The mains switch illuminates as green when the device is switched on. The device will immediately start to heat up when there is sufficient filling level in the pressure vessel (Chapter 5).

5 Description of the Operating Displays

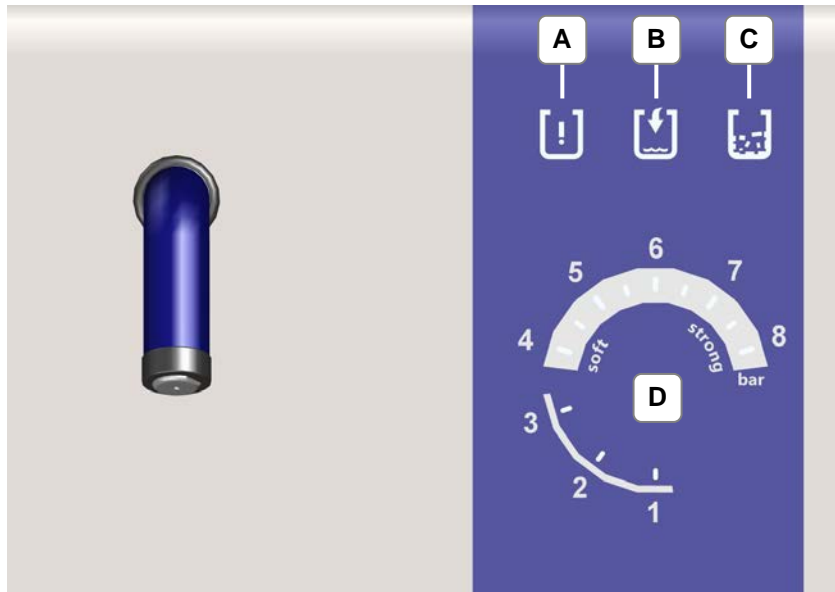
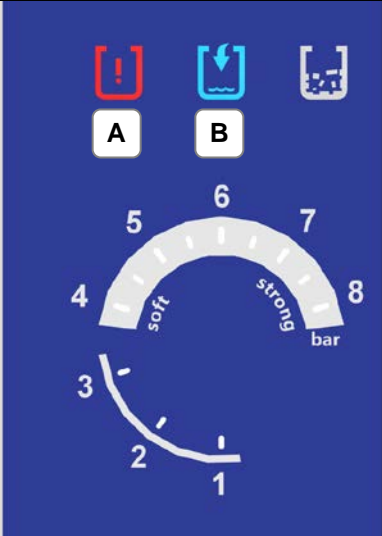
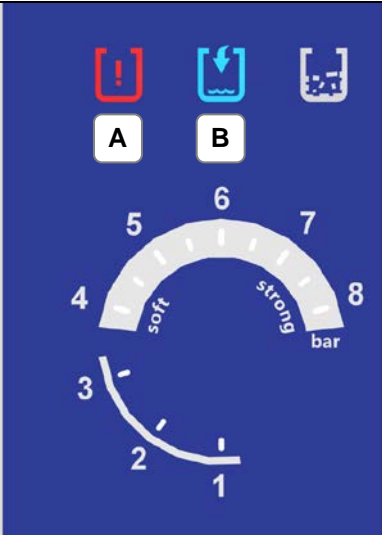

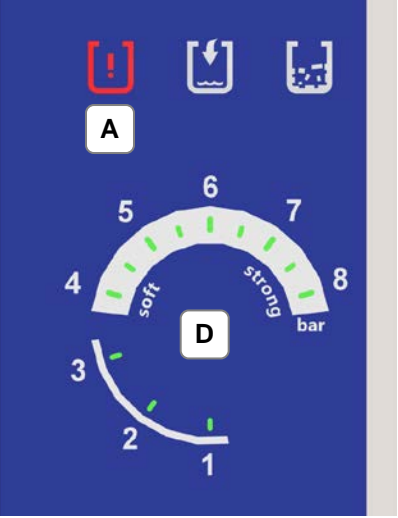

Figure 5.1: Operating Displays

- Warning (A)** Illuminates or flashes red for warnings for Filling Level/Descaling
- Filling Level (B)** Illuminates or flashes blue to signal the filling level status in the pressure vessel or the optional canister
- Service/Descaling (C)** Illuminates or flashes orange to signal descaling for the device
- Gauge (D)** Illuminates or flashes green to indicate the operating pressure, pressure value as well as the step display for the descaling programme
- Signal Tone** Sounds for warnings, signals the urgency

	Operating soft / strong	Pre-set operating pressure for the function soft or strong flashes green on the scale of values of the gauge (D)	The device heats up or cools to the pre-set operating pressure. The current achieved pressure illuminates on the scale of values. The device is ready for use when the scale of values illuminates up to operating pressure.
		Scales of values on gauge (D) illuminates as green	The currently achieved pressure values illuminate on the scale of values as 1 - 8. <i>Example:</i> At 2 bar pressure, the scale of values illuminates as 1-2.

	Filling Levels	<p>Filling Level (B) illuminates as blue</p> <p>The device is switched on at the mains switch and is depressurised!</p>	<p>The device is not completely filled.</p> <p>The filling level of the device is between minimum and maximum .</p> <p>The device can be filled.</p> <p>The display goes out as soon as the pressure is built up in the device.</p>
		<p>Filling Level (B) light goes out (When filling)</p>	<p>The device is completely filled.</p> <p>Do not continue to fill the device.</p>
		<p>Filling Level (B) flashes blue (Device with pump)</p>	<p>The filling level in the canister is low (min.).</p> <p>Fill the canister.</p> <p>Canister is not connected to the device.</p> <p>Inspect the connection cable to the canister.</p> <p>No or too low water pressure (minimum 1.6 bar).</p> <p>Open the water supply and/or inspect water pressure.</p>
		<p>Filling Level (B) flashes blue (Device without pump)</p>	<p>Reserve indicator, device and/or pressure vessel is nearly empty.</p>

	<p>Filling Level (B) illuminates as blue</p> <p>Warning (A) flashes red</p> <p>Warning Tone sounds continuously in operation soft/strong</p>	<p>Filling level low, below the minimum.</p> <p>Switch off the warning tone, select the function steam outlet or lock in the programme selection.</p> <p>Device with/without pump: Fill the device manually .</p> <ul style="list-style-type: none"> - Fill the device to filling level minimum, the display warning (A) goes out. - Fill the device to filling level maximum, the display warning (B) goes out.
	<p>Filling Level (B) flashes blue</p> <p>Warning (A) flashes red (Device with pump)</p>	<p>With automatic filling, the filling process will not be started (safety shut-down of the pump).</p> <p>Fill the device manually to filling level minimum (2 litres).</p> <p>Inspect the ventilation hose on the canister and, where necessary, connect it.</p> <p>Device with fixed-water supply: Inspect the hose connection.</p> <p>Switch off the device: Let it cool down.</p> <p>Switch on the device: automatic filling (depressurised devices start with the filling process again).</p>

	Warnings	<p>Warning (A) flashes red</p> <p>Gauge (D) flashes green (all scales of values flashing)</p>	<p>An excess pressure has been created in the device.</p> <p>Automatic shut-down of the heating.</p> <p>Switch the device On/Off.</p> <p>Device with compressed air: Inspect the compressed air pipes for pressure (maximum 6 bar).</p> <p>Inspect whether the device is in the function Service (Descale).</p>
		Service (Descale)	<p>Warning (A) flashes red</p>
<p>Service (Descale) (C) illuminates as orange</p>	<p>1. Command for the device to descale.</p>		
<p>Service (Descale) (C) flashes orange</p>	<p>2. Command for the device to descale.</p>		
<p>Service (Descale) (C) flashes orange</p> <p>Warning Tone sounds</p>	<p>3. Command for the device to descale.</p> <p>Warning Tone will sound for 20 seconds after switching on, if the device has not been descaled, then the Warning Tone sounds every 10 minutes.</p>		

Description of the Operating Displays

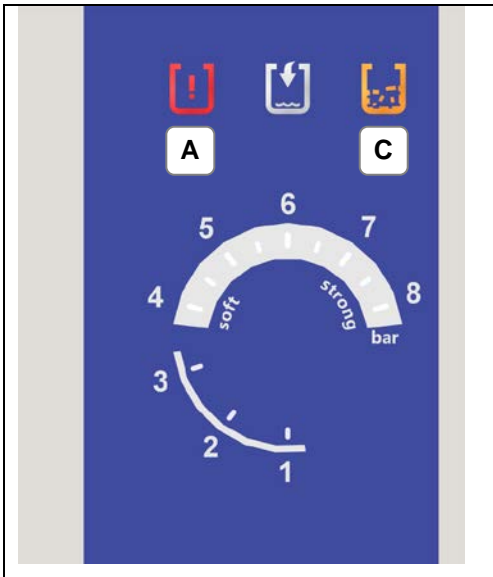
 <p>The image shows a control panel with a blue background. At the top, there are three indicator lights: a red one with an exclamation mark (labeled 'A'), a white one with a downward arrow (labeled 'B'), and an orange one with a scale icon (labeled 'C'). Below these is a semi-circular pressure gauge with numbers 1 through 8. The gauge is divided into two sections: 'soft' (from 1 to 5) and 'strong bar' (from 6 to 8). The needle is currently pointing to the number 1.</p>	<p>Service (Descale) (C) flashes orange</p> <p>Warning (A) illuminates as red</p>	<p>No operation is possible in the function soft or strong.</p> <p>Automatic shut-down of the heating (safety shut-down).</p> <p>Only after the descaling has been performed is it possible to reactivate the steam operation.</p>
-----------------------------------------------------------------------------------------------------------------------------------------------------------------------------------------------------------------------------------------------------------------------------------------------------------------------------------------------------------------------------------------------------------------------------------------------------------------------------------------------------------------------------------------------------------------------------	-------------------------------------------------------------------------------------------------	------------------------------------------------------------------------------------------------------------------------------------------------------------------------------------------------------------------------------------

6 Device filling/emptying

Let the heated up device cool down first

	CAREFUL
	<p>Escaping steam! Risk of scalding!</p> <ul style="list-style-type: none"> • Cool down the device before opening. • Open the pressure tank screw cap only in depressurised units. Observe the gauge display (Figure.6.1-D)! The device remains under pressure as long as one segment is illuminated on the value scale on the gauge. • Device with residual pressure. The scale on the pressure gauge indicator illuminates. Let the steam escape via steam outlet. The residual steam pressure must be discharged on the handpiece or on the fixed nozzle. • Ensure that the escaping steam will not endanger people, fixtures or equipment.

	INFORMATION
	<p>Operating Displays for Filling Level and Warning</p> <ul style="list-style-type: none"> • Level (B) flashes: no pump operation possible (Chapter 8.6) • Level (B) illuminates: If necessary, top up the device (filling level between minimum and maximum) The indicator (B) goes out as soon as pressure is built up in the device. • Level (B) does not illuminate: Device is full (filling level maximum) • Level (B) illuminates + Warning (A) flashes + Warning Tone, during the operation soft or strong. Top up the device (filling level below minimum.) The display for filling level goes out when the device is completely filled. • The warning (A) goes out as soon as the filling level minimum is achieved

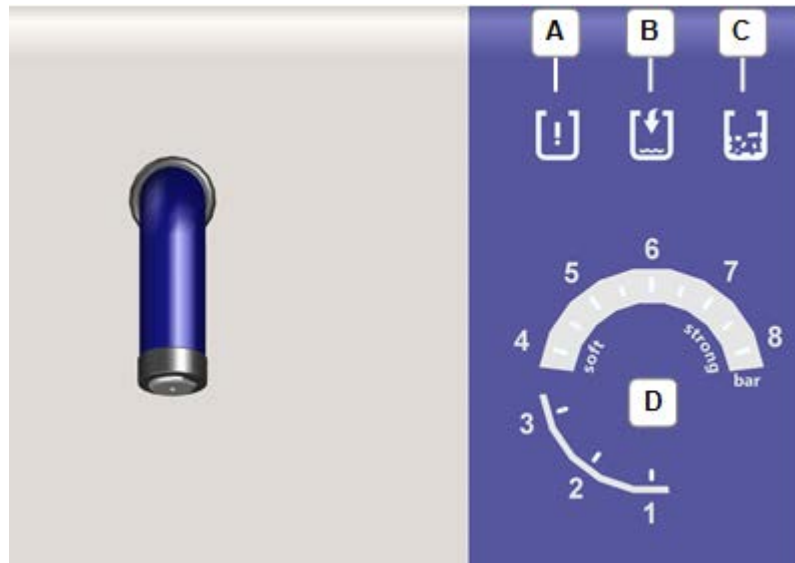



Figure 6.1: Operating Displays

- A Warning** illuminates/flashes red
- B Filling Level** illuminates/flashes blue
- C Service (Descaling)** - illuminates/flashes orange
- D Gauge** Scale of values illuminates/flashes green

6.1

Requirements for the Water Quality

	INFORMATION
	<p>Requirements for the Water Quality</p> <ul style="list-style-type: none"> • Only fill the unit with potable water or DI water. • If the water conductivity is < 2 µS/cm then, at commissioning (once!), the pressure vessel must be filled with 1 levelled-off teaspoon of table salt: For this purpose, firstly dissolve the salt in a glass of water and fill into the filling hole. • The salt does not go over into the vapour phase and thereby remains in the device. Therefore, the addition is only necessary during commissioning or after descaling, (Chapter 8.2).

	INFORMATION
	<p>Water Quality</p> <ul style="list-style-type: none"> • Preferably operate the device with DI water. The service life of the device can therefore be considerably extended. • Water quality can considerably influence the maintenance intervals and the cleaning results.

6.1.1

Determining the Water Quality

The quality of the water which is utilised will have a decisive influence on the service life and product safety of the device. The harder the water is, then the more often the machine must be descaled. Therefore, it is important to adjust the water hardness.

Measure before commissioning to determine the local water quality with the accompanying test strips Utilise the "Settings" Table (Figure 7.4.6.1) to set the programme number for the lime and chlorine content! Settings (Chapter 7.4.6).

	INFORMATION
	<p>Measuring the Water Quality</p> <ul style="list-style-type: none"> • Utilise the "Settings" Table (Figure 7.4.6.1) to set the programme number for the DI water or softened water! Settings (Chapter 7.4.6). • When using DI water, the de-calcification levels 1 + 2 must be executed.

6.2

Manual Filling

	INFORMATION
	<p>Pressure-free device</p> <ul style="list-style-type: none"> • Commence the filling with Point 2 for pressure-free devices. Observe the gauge display! The device remains under pressure as long as one segment is illuminated on the value scale on the gauge. • Always firstly discharge the pressure with heated up devices! Observe the gauge display, pressure values illuminate as green when the pressure vessel is pressurised! Commence the filling with Point 1.

	INFORMATION
	<p>The device is switched off and depressurised.</p> <ul style="list-style-type: none"> • Observe the maximum filling capacity (Chapter 3.4 Technical Data). • Fill the device slowly to prevent overfilling.

Prerequisite

The commissioning was executed (Chapter 4).

The device is switched on at the mains supply switch!

The device is ready for use!

**Pressure reduction
with operating display
filling level**

1. Let the remaining steam pressure discharge through the nozzle. Utilise hereby the function **steam outlet** (Chapter 7.4.1).

1.1. Device version with manual unit:

1.1.1 Hold the manual unit in a sink or in a bucket until no steam discharges any more.

1.1.2 Hold down the steam button for 2 seconds to discharge any residual steam vapour pressure. Steam escapes permanently. To interrupt, press the steam button again.

1.2 Device version with fixed nozzle:

1.2.1 Position the unit with a fixed nozzle over a sink or suitable bucket until no more steam discharges.

1.2.2 Hold down the foot switch for 2 seconds to discharge any residual steam vapour pressure. Steam escapes permanently. To interrupt, press the foot switch again.

Allow to device to cool down after pressure build-up

	CAREFUL
	<p>Escaping steam! Prevent scalding caused by unforeseen vapour formation during filling!</p> <ul style="list-style-type: none"> • Allow the device to cool down after full pressure discharge for approx. 5 minutes. • Do not lean over the filling opening of the pressure vessel during filling.

2. Slowly open the pressure vessel screw cap as residual steam can escape laterally from the pressure vessel screw cap.
3. Insert the sieve (Figure 6.2.2) from the scope of delivery into the collection tray.

	WARNING
	<p>Possible short circuit in the device from the ingress of water into the housing! Electric shock, serious injury!</p> <ul style="list-style-type: none"> • Refill with water slowly. • Avoid overfilling. Observe the operating displays. • Water must not ingress into the ventilation slots of the device cover. • Regularly inspect the seal on the pressure vessel screw cap. • Replace the seal on the pressure vessel screw cap when damaged or leaking.

Filling the pressure vessel

4. Refill with water slowly.

Ensure that you do not overfill the pressure vessel. Observe the operating display for the filling level (the display level goes out when the maximum level has been achieved).

The filling level is displayed on the operation display:

- The operating display warning will go out when the minimum filling level has been achieved.
- The operating display warning will go out when the maximum filling level has been achieved.

Observe the operating displays

5. The pressure vessel is completely filled when the operating display for the filling level goes out.
6. Remove the sieve.
7. Wipe away any overflowing water.

Close the pressure vessel screw cap

8. Close the pressure tank screw cap manually (hand tight).

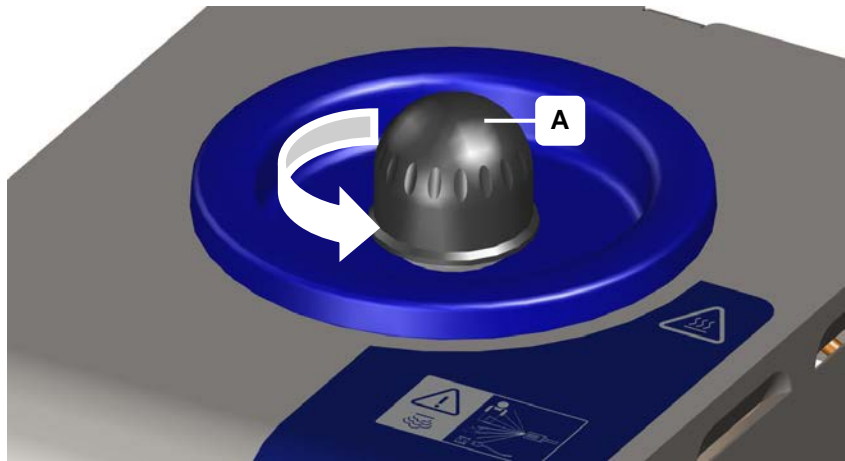

Figure 6.2.1: Opening/closing the pressure vessel

- A** Open the pressure tank screw cap (in arrow direction)

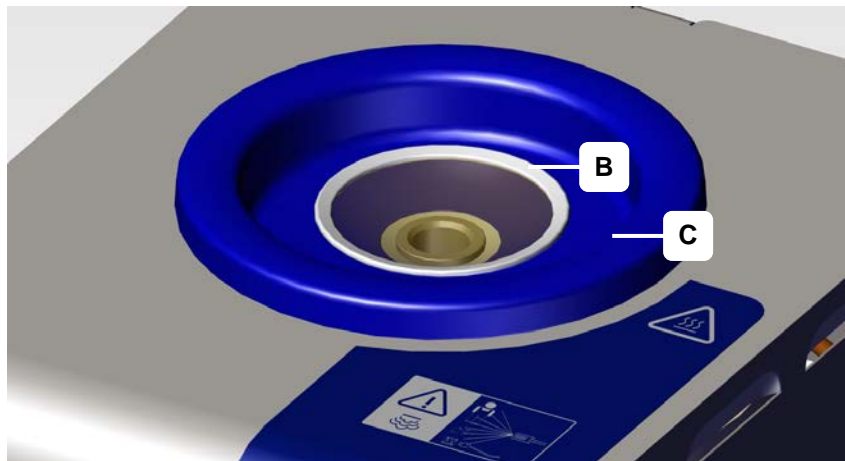



Figure 6.2.2: Laying the sieve into the collecting tray

- B** Sieve
- C** Collection Tray for overflowing water when filling

6.3 Automatic Filling with Pump (optional)

Unit requirements

Only for units connected to an on-site fixed water supply or with a cannister

	INFORMATION
	Intelligent pump control, pump operation during application breaks.

Water quality requirements

For the automatic filling, both potable water and completely desalinated DI water can be used.

	INFORMATION
	<ul style="list-style-type: none"> • Fill the unit with mains water, softened water or deionised water only. • If the water's conductivity is $< 2 \mu\text{S/cm}$, mains water must be used once for the first fill during initial operation or after descaling. • This one-time filling with mains water ensures that the automatic refill functions properly during regular operation, as a result of the water's conductivity. • The maintenance intervals are longer if the unit is operated with softened or deionised water.



A pump ensures the optimal level

The pump automatically fills the pressure vessel with the optimum filling amount of water. There is no waiting time caused by necessary cooling phases as with the manual filling.

As soon as the water level is lowered in the pressure vessel, then the pump automatically fills the pressure vessel to the optimum filling level.

6.3.1

Filling with Fixed-water Connection (option)

	CAREFUL
	<p>Possible brackish water back flow into the water supply! Contamination of potable water!</p> <ul style="list-style-type: none"> • Install a backflow prevention system between building-side water connection and the device. • The operator is responsible for implementing the measure.
	CAREFUL
	<p>Possible loosening of the water hose! Water damage!</p> <ul style="list-style-type: none"> • Always close the water supply of the pump on the water tap after the operation and when the machine is unattended.
	CAREFUL
	<p>Pump damage!</p> <ul style="list-style-type: none"> • Only connect the pump to a potable water supply of drinking water, or preferably to a softening / desalination plant. • Conductivity must be at least 2 µS/cm.

Prerequisite The commissioning was executed. (Chapter 4)
 The device is connected to a fixed-water supply. (Chapter 4.4 Installation of a fixed-water supply)
 The device is switched on at the mains supply switch!
 The device is ready for use!
 The pressure vessel is completely filled or filled above the minimum level.

Procedural Method If the pressure vessel is empty or below the minimum fill level, then fill the pressure vessel in advance manually with about 2 litres of water (Chapter 6.2).

1. Open the on-site water tap for the water supply.
2. The automatic filling or refilling starts approximately 30 seconds after switching on the device.
3. During the operation, the filling will be regulated via the filling level monitoring.

6.3.2 Initial Filling with the Canister (option)

When there is no pressure pipe connection with potable water available, then the pump can also be supplied via an external canister. To do this, only utilise the original accessories from the manufacturer.

Prerequisite The commissioning was executed. (Chapter 4 Commissioning)
The device is connected to the canister. (Chapter 4.5 Installation Water connection with canister)

The device is switched on at the mains supply switch!

The device is ready for use!

Preparation Fill the pressure vessel in advance manually with about 2 litres of water (Chapter 6.2 Manual filling).

Fill the canister with potable water or DI water.

- Procedural Method**
1. The automatic filling or refilling starts approximately 30 seconds after switching on the device.
 2. During the operation, the filling will be regulated via the filling level monitoring.
 3. The operating display for the filling level flashes when the filling level of the canister is down to the minimum.
 4. Fill the canister with the funnel when the operating display illuminates. The canister can be refilled during operation.

6.4

Draining the Device

WARNING	
	<p>Hot vapours/hot liquids Injuries caused by scalding!</p> <ul style="list-style-type: none"> • Never open the drain cock when an excess pressure of > 0 up has built up in the pressure vessel! • Observe the gauge display! As long as the scale of values on the gauge is illuminated, then the device is under pressure! • Open the pressure tank screw cap slowly! • The residual water may be hot! • Wear heat resistant gloves when handling the maintenance hose! • Secure the maintenance hose in the sink or suitable bucket against detachment!

INFORMATION	
	<p>The ball valve will get hot during operation!</p> <ul style="list-style-type: none"> • To avoid that people could be burned in case of accidental contact with the ball valve and to avoid that adjacent cables or wires are scorched, protection against accidental contact has been installed. • Do not remove the protection against accidental contact.



Figure 6.4.1: Ball valve **Open**



Figure 6.4.2: Ball valve **Closed**

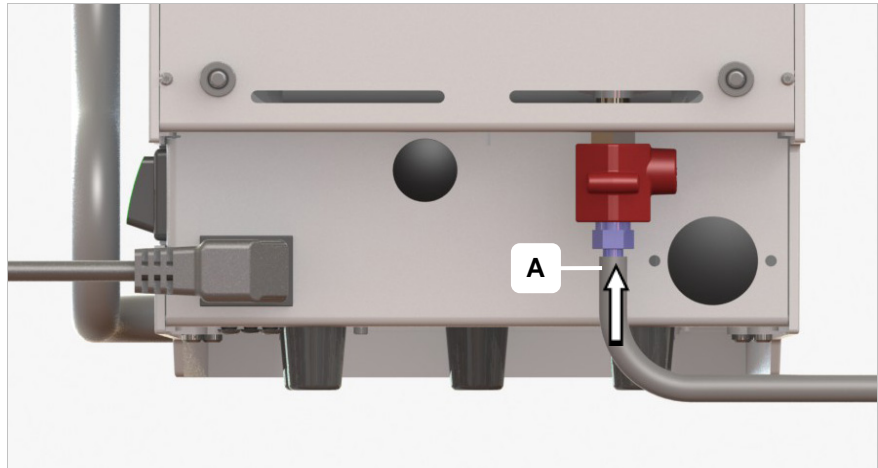





Figure 6.4.3: Connecting the maintenance hose to the ball valve

- Preparation**
1. Allow the unit to cool down until it is depressurised (0 bar). Observe the gauge display. After the drop in pressure is completed, allow the device to cool down for approx. 5 minutes.
 2. Slowly open the pressure tank screw cap (Figure 6.2.1 Device fill).
- Procedural Method**
3. Connect the maintenance hose (scope of delivery) on the connection pipe of the ball valve (Figure 6.4.3).
 4. Position the other end of the hose in a sink or in a bucket. Secure the maintenance hose in the sink or suitable bucket against detachment.
 5. Open the ball valve (Figure 6.4.1).
 6. Drain the water from the pressure vessel.
 7. Connect to the ball valve after emptying (Figure 6.4.2).

7

Handling in Operation

	WARNING
	<p>Hot steam jets! Injuries caused by burns or scalding!</p> <ul style="list-style-type: none"> During operation of the steam cleaner there cannot be any unauthorised people in the range of the steam vapour stream. Prevent any dangerous situations that may result from inadvertent steam outlet. Switch off the device during application breaks to  lock. Always handle the steam cleaner with extreme care.

	WARNING
	<p>High temperatures on the surface of the device, the steam outlet nozzle and the drain cock! Injuries from burns!</p> <ul style="list-style-type: none"> Only touch the said areas with personal protective equipment (e.g. protective gloves) Allow the unit to cool down before touching any part thereof.

	INFORMATION
	<p>Rotary knob for programme selection: Turn the rotary knob to select the function and press the rotary knob to confirm the selection. The selected programme lights up as blue on the display segment (point). The device settings are pre-set to the factory settings (Table in Chapter 7.4.6.1 Settings).</p>

	INFORMATION
	<p>Switch on the device: After switching on the device, the pressure vessel will be vented. Short hissing noises can be repeated several times.</p>

Prerequisites	The commissioning was executed (Chapter 4)
Pressure vessel is filled	The pressure vessel was filled (Chapter 6). The device is switched on at the mains supply switch! The device is ready for use!
soft / strong / steam outlet	Set the programme for soft , strong , steam outlet on the programme selection. Soft setting for the steam range 4 - 6 bar (Chapter 7.4.2). Strong setting for the steam range 6 - 8 bar (Chapter 7.4.3). Steam Outlet for discharging residual steam pressure (Chapter 7.4.1).
Saturated Steam	Saturated Steam (optional) the saturated steam proportion will be set by the rotary knob wet/dry (Chapter 7.3).

	INFORMATION
	The device has been pre-set at the factory. Amending the factory settings (Chapter 7.4.6 Settings).

Ready for Operation

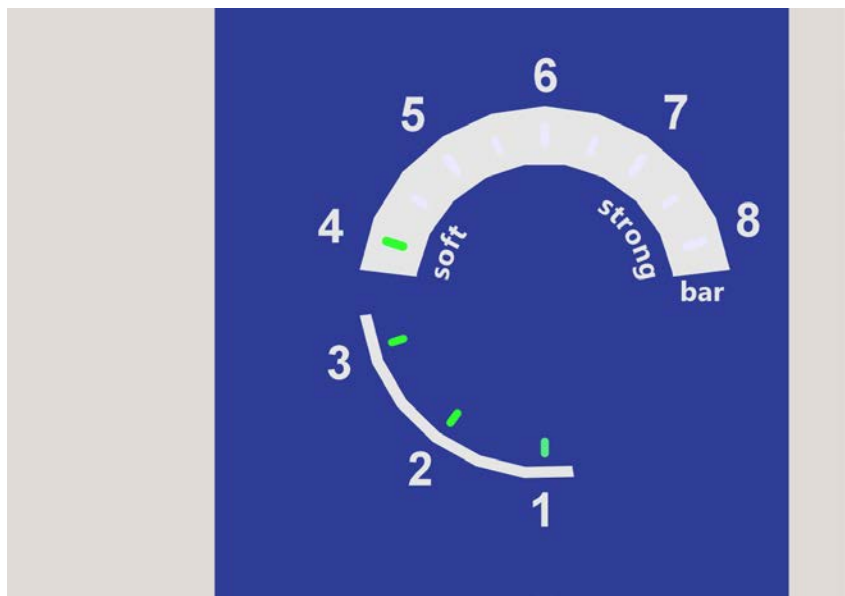



Figure 7.1: Gauge





The device has achieved the operating pressure when all the pressure values illuminate until the operating pressure green. (e.g. at 4 bar operating pressure, the scale of values illuminates as 1 - 4 on the gauge (Figure 7.1).

	INFORMATION
	To prevent accidental steam outlet, turn off the device during application breaks to  lock (Chapter 7.4.4).

Holding the work piece	Utilise approved accessories to ensure secure retention of smaller work pieces. e.g. forceps, sieve etc.
Approval for materials to be cleaned	Before commencing any cleaning works, always inform yourself about whether the work piece, trinket or orthodontic material to be cleaned is suitable for this cleaning process. In particular, the thermal and mechanical load has to be taken into account.
Distance to the steam outlet	Keep the work piece at least 1 cm away from the nozzle in the vapour zone. Control at frequent intervals the cleaning success (visual inspection) as well as any possible adverse effects on sensitive surfaces of the cleaning material.
Cleaning Result	The user is responsible for the control of the cleaning result.

7.1

Working with the Handpiece

	<p>WARNING</p>
	<p>High temperatures on the nozzle! Serious injuries from burns!</p> <ul style="list-style-type: none"> • Only touch the said areas with personal protective equipment (e.g. protective gloves). • Allow the unit to cool down before touching any part thereof.
	<p>CAREFUL</p>
	<p>Hot steam escapes! Risk of scalding!</p> <ul style="list-style-type: none"> • Handpiece • Escaping steam must not pose a danger to people or equipment. • Pay attention to your own safety! Use caution when the steam outlet is activated. • Prevent any dangerous situations that may result from inadvertent steam outlet. • Never align the steam/compressed air jets at people. • Never immerse the plastic handle of the manual unit in water.
	<p>CAREFUL</p>
	<p>Hot steam escapes! Risk of scalding!</p> <ul style="list-style-type: none"> • Handpiece • Escaping steam must not pose a danger to people or equipment. • Pay attention to your own safety! Use caution when the steam outlet is activated. • Prevent any dangerous situations that may result from inadvertent steam outlet.
	<p>INFORMATION</p>
	<p>Steam operation steam outlet: Steam escapes permanently from the steam nozzle when the steam button is pressed for a minimum of 2 seconds. To interrupt, press the steam button again. Or press or turn the rotary knob to interrupt the steam flow.</p>

	INFORMATION
	<p>Electrostatic discharge during working with the handpiece possible (chapter 2.3).</p>

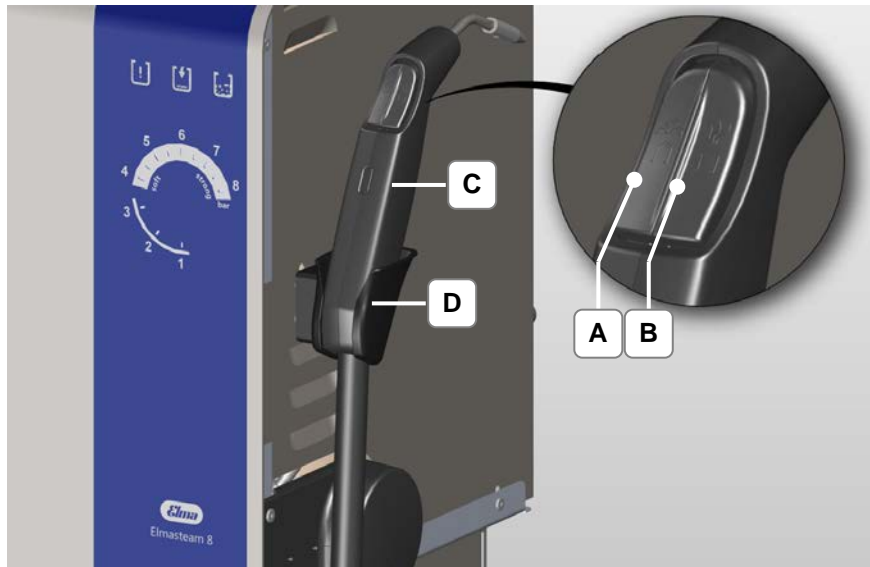

Figure 7.1.1: Handpiece

Steam operation with the handpiece for **soft, strong, steam outlet** or saturated steam.

Procedural Method

1. Take the handpiece (C) from the manual unit holder (D).
2. Align the manual unit into an appropriate bucket or sink to discharge any possible condensate accumulations. Briefly press the steam button (A) until steam appears.
3. Press steam button (A) to start the steam function. Both buttons (A+B) can be pressed for the steam function. The handle of the manual unit heats up slightly.
4. Moisten the material to be cleaned with steam from the handpiece (C).
5. Release steam button (A) or (A + B) to finish the steam function.
6. Hang the handpiece back into the manual unit holder.

Compressed air (option)

7. For devices with compressed air connection (optional).
8. Press the compressed air button (B) to start the compressed air function.
9. Blow the material to be cleaned with compressed air.
10. Release the compressed air button (B) to finish the compressed air function.
11. Hang the handpiece (C) back into the manual unit holder (D).

7.2

Working with the Fixed Nozzle

	WARNING
	<p>High temperatures on the nozzle! Serious injuries from burns!</p> <ul style="list-style-type: none"> Only touch the said areas with personal protective equipment (e.g. protective gloves). Allow the unit to cool down before touching any part thereof.

	CAREFUL
	<p>Hot steam escapes! Risk of scalding!</p> <ul style="list-style-type: none"> Escaping steam must not pose a danger to people or equipment. Pay attention to your own safety! Use caution when the steam outlet is activated. Prevent any dangerous situations that may result from inadvertent steam outlet.

	INFORMATION
	<p>Steam operation steam outlet: Steam escapes permanently from the steam nozzle when the foot switch is pressed for a minimum of 2 seconds. To interrupt, press the foot switch again. Or press or turn the rotary knob to interrupt the steam flow.</p>



Figure 7.2.1: Fixed Nozzle

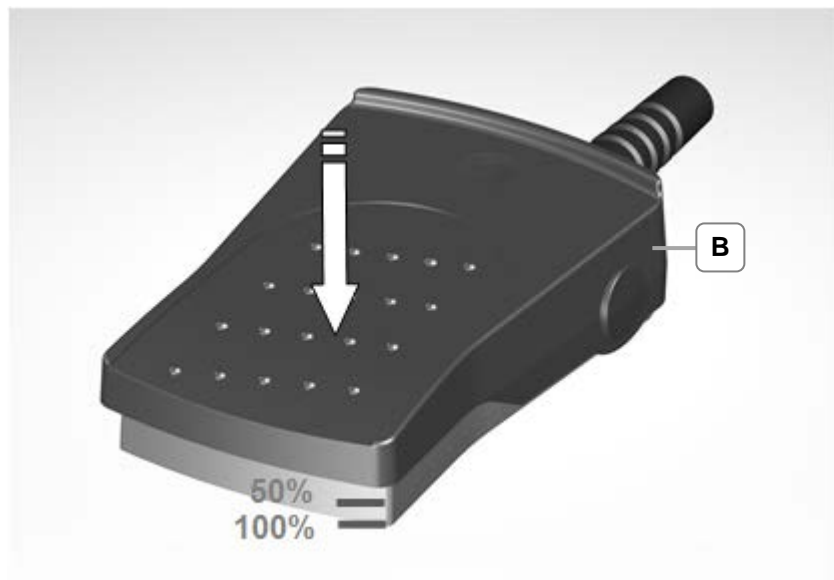

Figure 7.2.2: Foot Switch

- | | |
|---------------------------|----------------------------------------------------------------------------------------------------|
| Foot Switch | The foot switch enables you to control the steam vapour/compressed air outlet at the fixed nozzle. |
| Switching Position | There are 2 switching positions available: |
| 50 % Pressed | Activates compressed air to the nozzle. |
| 100 % Pressed | Activates steam to the nozzle. |

Steam operation with the fixed nozzle for **soft, strong, steam outlet**.

- Procedural Method**
1. Hold a suitable bucket under the fixed nozzle (7.2.1-A) to drain off any possible condensate water. Briefly press the foot switch (7.2.2-B) until steam exits.
 2. Press the foot switch (7.2.1-B) to start the steam function.
 3. Moisten the material to be cleaned with steam from the fixed nozzle (7.2.1-A).
 4. Release the foot switch (7.2.2-B) to finish the steam function.
- Compressed air (option)** For devices with compressed air connection (optional).
5. Press the foot switch (7.2.2-B) slightly (50 %) to start the compressed air function.
 6. Blow the material to be cleaned with compressed air.
 7. Release the foot switch (7.2.2-B) to finish the compressed air function.

7.3

**Operation with Saturated Steam wet/dry
(option for device with pump)**

	CAREFUL
	<p>Hot steam escapes! Risk of scalding!</p> <ul style="list-style-type: none"> Escaping steam must not pose a danger to people or equipment. Pay attention to your own safety! Use caution when the steam outlet is activated. Prevent any dangerous situations that may result from inadvertent steam outlet.

	INFORMATION
	<p>Saturated steam is available on the handpiece (Chapter 7.1 Working with the handpiece). The percentage of moisture in the saturated steam is set by utilising the rotary knob wet/dry.</p>



Figure 7.3.1: Setting the saturated steam function

- wet (A)** **Regulating the saturated steam proportion** for the mixing ratio of the saturated steam function.
- dry (B)** **Regulating the dry steam proportion** for the mixing ratio of the saturated steam function.

Procedural Method

1. Turn the rotary knob completely in the direction **wet** (A) for 100 % saturated steam.
2. Turn the rotary knob completely in the direction **dry** (B) for 100 % dry steam.
3. Turn the rotary knob during the steam operation towards wet or dry to adjust the mixing ratio.

7.4

Programme Selection



INFORMATION	
	<p>Rotary knob for programme selection: Turn the rotary knob to select the function and press the rotary knob to confirm the selection.</p> <p>The selected programme lights up as blue on the display segment (point).</p> <p>The programmes:</p> <ul style="list-style-type: none"> • steam outlet • soft • strong •  lock • service (descaling) •  Setting <p>are described in the following chapters.</p> <p>The device is pre-set to the factory settings (Table Chapter 7.4.6.1 Settings).</p>



Figure 7.4.1: Rotary knob, programme selection

7.4.1 Selecting the Steam Outlet

INFORMATION	
	<p>Steam escapes permanently from the steam nozzle when the steam button/foot switch are pressed for a minimum of 2 seconds. Press the steam button/foot switch again to interrupt the process. You can also press the rotary knob to interrupt the process.</p>



Figure 7.4.1.1: Programme selection, steam outlet

Function for discharging residual steam pressure. Before opening the pressure vessel screw cap e.g. for manual refilling, before emptying.

Procedural Method

1. Set the rotary knob to **steam outlet**.
2. Press the rotary knob to confirm.
3. Discharge the residual steam pressure on the fixed nozzle or handpiece.
4. Please observe the Chapter 7.1 Working with the handpiece or the Chapter 7.2 Working with the fixed nozzle.

7.4.2

Selecting Soft

INFORMATION	
	<p>The selected programme lights up as blue on the display segment (point).</p> <p>The setting for the steam range soft is pre-set at the factory and can be amended in the programme settings (Chapter 7.4.6 Settings).</p>



Figure 7.4.2.1: Programme selection, **soft**

For use in the steam range of 4 - 6 bar (adjustable in 0.5 bar increments).

Procedural Method

1. Set the rotary knob to **soft**.
2. Press the rotary knob to confirm.
3. Utilise the steam via the fixed nozzle or the handpiece.
4. Please observe the Chapter 7.1 Working with the handpiece or the Chapter 7.2 Working with the fixed nozzle.

7.4.3 Selecting strong

INFORMATION	
	<p>The selected programme lights up as blue on the display segment (point).</p> <p>The setting for the steam range strong is pre-set at the factory and can be amended in the programme settings (Chapter 7.4.6 Settings).</p>



Figure 7.4.3.1: Programme selection, strong

For use in the steam range of 6 - 8 bar (adjustable in 0.5 bar increments).

Procedural Method

1. Set the rotary knob to **strong**.
2. Press the rotary knob to confirm.
3. Utilise the steam via the fixed nozzle or the handpiece.
4. Please observe the Chapter 7.1 Working with the handpiece or the Chapter 7.2 Working with the fixed nozzle.

7.4.4 Selecting lock





INFORMATION	
	<p>The selected programme lights up as blue on the display segment (point).</p> <p>The time setting for the function  lock is pre-set at the factory and can be amended in the programme settings (Chapter 7.4.6 Settings).</p>



Figure 7.4.4.1: Program selection lock

Utilise the function  **lock** for application pauses, to avoid accidental steam discharges.

Procedural Method

1. Set the rotary knob to  **lock**.
2. Press the rotary switch to confirm.
3. The steam button and foot switch are deactivated.

Automatic Lock

INFORMATION	
	<p>The device switches automatically to lock after the set time has expired.</p> <p>The steam application is ready for use once you have selected the soft, strong or steam outlet programmes.</p> <p>After the interval time to eco, the pressure reduces to 3 bar (Chapter 7.4.7 Settings).</p>

7.4.5 Service (Descaling)

	INFORMATION
	<p>Utilise the programme service when you want to descale the device. You require the flushing set and the maintenance hose (provided accessories) for descaling.</p> <ul style="list-style-type: none"> • The selected programme lights up as blue on the display segment (point). The programme service (descaling) can only be started when the device is depressurised! • The gauge displays the descaling steps 1 - 8. The current de-calcifying step illuminates or flashes as green on the gauge. • The descaling programme cannot be interrupted! Duration approx. 2.5 hours (including reaction time). • Descal the device when the operating display Service illuminates on the device (Chapter 3.6.3 Operating Displays). 3 warning levels request descaling. A safety shut-down of the heating will be executed when you do not perform the descaling process! • The descaling intervals are longer if softened water is used..

	INFORMATION
	<p>Descaling with DI water</p> <ul style="list-style-type: none"> • When you operate the device with DI water, descaling is ended after the descaling step 2 Preparation Step 3 "citric acid" is omitted.

	WARNING
	<p>Hot steams / Hot liquids</p> <p>Risk of scalding from steam!</p> <ul style="list-style-type: none"> • Only open the pressure vessel screw cap when the device is depressurised! • Allow the pressure vessel to cool down before opening the pressure vessel screw cap! • Observe the pressure gauge (Figure 7.4.5.2)! The device remains under pressure as long as one segment is illuminated on the value scale on the gauge. • The residual water may be hot! • Wear heat resistant gloves when handling the hose • Only utilise pure citric acid as 3 % to 1.5 litres of potable water or DI water for descaling.

	CAREFUL
	<p>Risk of injury! Injuries can be caused by chemical burns on the skin!</p> <ul style="list-style-type: none"> • Never fill chemicals into the device! • Only utilise pure citric acid as 3 % in 1.5 litres of potable water or DI water for descaling processes!



Figure 7.4.5.1: Rotary knob programme selection, service

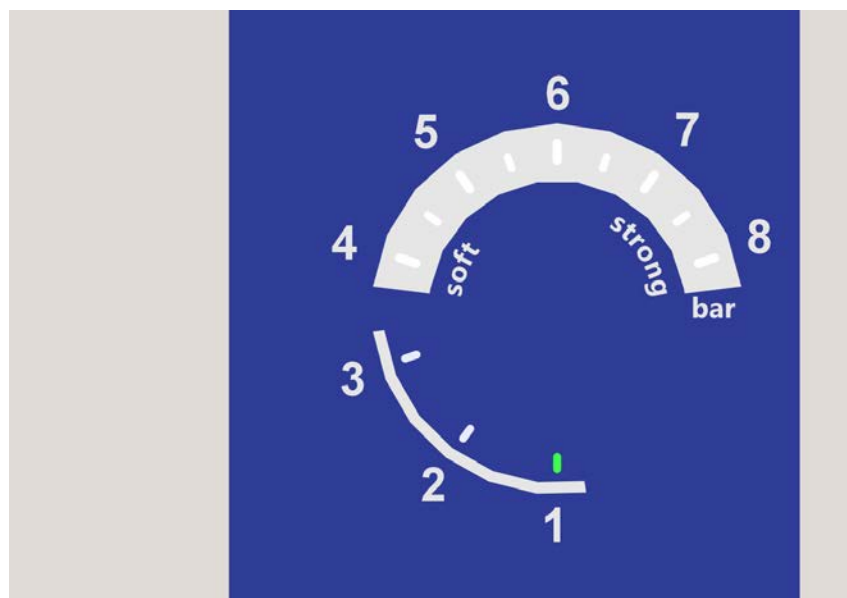

Figure 7.4.5.2: Gauge display **descaling 1 - 8**

Preparation

1. Connect the maintenance hose to the ball valve (Figure 6.4.3).

2. Place the prepared flushing set (provided accessory). Also refer to Chapter 8.2 Rinsing the pressure vessel!
3. Dissolve **3 % of pure citric acid** in 1.5 litre of potable water or ID water. Fill therefore 1.5 litres of water into a measuring cup and dissolve in 45 g of pure citric acid (3 heaped tablespoons).

Procedural Method

1. Set the rotary knob (Figure 7.4.5.1) to **service**.
2. Press the rotary knob 2 seconds to confirm.
 - The **descaling step 1** on the gauge (Figure 7.4.5.2) illuminates as green.
3. Open the pressure vessel screw cap (Figure 6.2.1 Manual filling).
4. Drain the device completely via the ball valve (Chapter 6.4 Draining).
5. Press the rotary knob to continue with the **descaling step 2**.
 - The **descaling step 2** on the gauge (Figure 7.4.5.2) illuminates as green.
6. Subsequently rinse the device with the rinsing set until no more lime deposits are flushed out (Chapter 7.4.5.1 pressure vessel).
7. Press the rotary knob to continue the **descaling step 3**.
 - The **descaling step 3** on the gauge illuminates as green.
8. Close the ball valve (Chapter 6.4 Draining).
9. Fill the descaling agent (pure citric acid 3 % to 1.5 litres of potable water) through the filler opening in the device (Chapter 5.2 Manual filling).



INFORMATION

* Immediately wipe up any citric acid mix spillage or spatter to avoid discolouration of the filling opening.





10. Close the pressure tank screw cap.
11. Press the rotary knob to continue the **descaling step 4**.
 - The **descaling step 4** on the gauge flashes green. The device heats up (warm-up time).
 - The **descaling step 5** on the gauge illuminates as green (warm up time is completed).
Reaction time! Duration, approximately 2 hours.

Recommendation

	INFORMATION
	<p>We recommend to let the solution react overnight. You can switch off the device during the reaction time. The pressure will be dissipated in the pressure vessel overnight. If the device is switched on after the reaction time, then the gauge automatically switches to descaling step 6. The prerequisite hereby is that the pressure vessel is depressurised!</p>

- The **descaling step 6** on the gauge illuminates as green.
- 12. Open the pressure vessel screw cap (Figure 6.2.1 Manual filling).
- 13. Drain the device completely via the ball valve (Chapter 5.4 Draining).
- 14. Press the rotary knob to continue with the **descaling step 7**.
 - The **descaling step 7** on the gauge illuminates as green.
- 15. Close the ball valve (Chapter 6.4 Draining).
- 16. Fill the device with potable water or DI water* (Chapter 6.2 Manual Filling).
- 17. Press the rotary knob to continue the **descaling step 8**.
 - The **descaling step 8** on the gauge illuminates as green.
- 18. Drain the device completely via the ball valve (Chapter 6.4 Draining).
- 19. Close the ball valve (Chapter 6.4 Draining).
- 20. Press the rotary knob to exit the descaling process.

The function  **lock** illuminates. The device switches after descaling automatically to **lock** (Chapter 7.4.4).

	INFORMATION
	<p>*Fill the unit as described in section 6.2 to put it back into operation.</p>

7.4.5.1 Flush the Pressure Vessel

INFORMATION	
	Use the flushing set (Figure 7.4.5.1.1) to flush the pressure vessel (flushing set included in the scope of delivery).

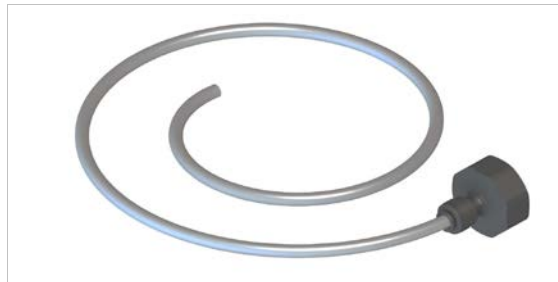

Figure 7.4.5.1.1: Flushing set for connecting to the water tap (3/4")

- Preparation**
- Allow the unit to cool down until it is depressurised (0 bar). After completion of the pressure discharge, the device still needs to cool down for approx. 5 minutes to avoid spontaneous formation of steam when flushing.
 - Place the flushing set (Figure 7.4.5.1.1) and the maintenance hose from the scope of delivery in a position ready for use.

- Procedure for Flushing**
1. Open pressure tank screw cap (Chapter 6.2 Filling the device).
 2. Connect the maintenance hose (Figure 7.4.5.1.2) to the connecting mounting on the ball valve.
 3. Position the device in such a way that the maintenance hose hangs into a sink or bucket large enough for this operation and that the ball valve can be operated.
 4. Open the ball valve with a screwdriver (Figure 7.4.5.1.3) and initially drain off any residual water which may be in the device.
 5. Connect the flushing set to a water tap (3/4").
 6. Utilise the hose from the flushing set to flush out the pressure vessel in a circular motion.
This process must be continued until no more lime deposits are purged from the pressure vessel.
The water is thereby able to quickly flow out of the pressure vessel *.
 7. Close the ball valve (Figure 7.4.5.1.4).
 8. Remove the maintenance hose (Figure 7.4.5.1.2).
 9. For devices that are operated in combination with a pump for deionised water: Fill 1 levelled-off teaspoon of salt into the pressure container after flushing (Chapter 6.2).

* If water does not flow out despite the ball valve being opened then this normally indicates that there are lime scale blockages: Remove the maintenance hose and free up the opening in the ball valve with a thin object. Or flush out the ball valve with the flushing set. Insert the flushing hose in the hose sleeving or directly in the ball valve.

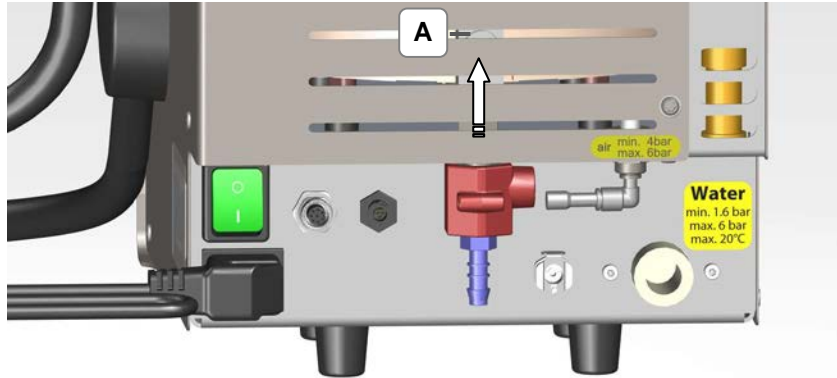

Figure 7.4.5.1.2: Connecting the maintenance hose to the ball valve





Figure 7.4.5.1.3: Ball valve **Open**



Figure 7.4.5.1.4: Ball valve **Closed**

7.4.6

Settings

INFORMATION	
	<p>Use the programme for  settings to amend the settings. Utilise the table (Chapter 7.4.6.1 Settings) for this.</p> <p>Settings for the following programmes are displayed on the pressure gauge:</p> <ul style="list-style-type: none"> 1=soft, 2=strong, 3=time to lock 4=time to eco, 5=water hardness (lime), 6=chlorine content and 8=factory setting <p>The device has been pre-set at the factory. The factory settings can be amended. Utilise the table (Chapter 7.4.6.1 Settings) for this.</p> <p>After every adjustment, or after 30 seconds, the device switches to the function  lock.</p>



INFORMATION	
	<p>Turning the rotary knob via settings or steam outlet away, then the device will switch to the  lock function.</p>



Figure 7.4.6.1: Programme selection, settings

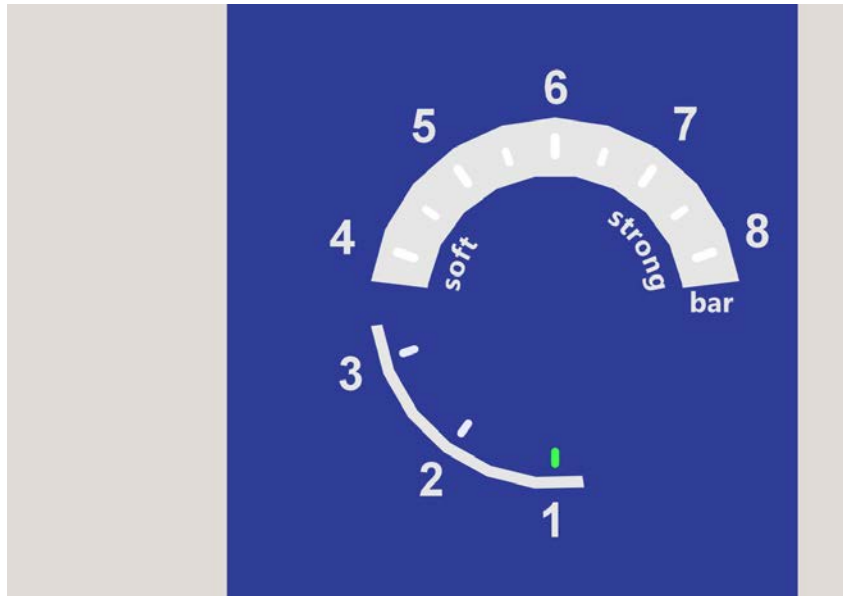



Figure 7.4.6.2: Gauge display, settings programme 1 - 8

Procedural Method

1. Set the rotary knob (Figure 7.4.6.1) on  **settings**.
2. Press the rotary knob (Figure 7.4.6.1) for 2 seconds to confirm.
 - To change the device settings, utilise the table for settings (Chapter 7.4.6.1 Settings)!
3. The scale of values 1 (adjust steam to **soft**) flashes on the gauge (Figure 7.4.6.2).
4. Turn the rotary knob until the scale of values on the pressure gauge indicates the programme number to be amended.

Programme numbers:

 - 1** = Set steam pressure for **soft** 4 - 6 bar
 - 2** = Set steam pressure for **strong** 6 - 8 bar
 - 3** = Set time for time to lock 0 - 105 minutes
 - 4** = Set time for time to **eco*** 0 - 7 hours
 - 5** = Set measured **Water hardness** * 0 - 20°dH
 - 6** = Set measured **chlorine content*** 0 - 200 mg/l
 - 8** = Reset to **factory default** settings
5. Press the rotary knob to confirm the programme number.
 - The last value set will be displayed on the gauge. This value will turn green on the scale of values.
6. Turn the rotary knob to amend the value. The possible setting is displayed on the pressure gauge by the flashing values. If you exceed or are under the possible setting range, then the values will not flash any more. Turn back

the rotary knob into the possible range of values until the values that can be set start to flash again.

7. Press the rotary knob to confirm the set value.
 - The function  **lock** illuminates. The device switches after setting automatic to **lock** (Chapter 7.4.4).
8. Start with **1.** to assume an additional setting!
 - * Time to eco, after a set time between 0 - 7 hours, then the set pressure range drops to 3 bar.
 - * Determine hardness, refer to the information data sheet "Water Quality".
 - * Determine chlorine content, refer to the data sheet "Water Quality".

7.4.6.1

Settings

	INFORMATION
	The factory setting values are highlighted in grey in the Table 7.4.6.1.

Programme-Number	Programme Selection														
1	Steam soft	Value (bar)	4	4.5	5	5.5	6								
		Gauge	4	4.5	5	5.5	6								
2	Steam strong	Value (bar)	6	6.5	7	7.5	8								
		Gauge	6	6.5	7	7.5	8								
3	Time to lock	Time (min)	Off	15	30	45	60	75	90	105					
		Gauge	1	2	3	4	5	6	7	8					
4	Time to eco	Time (h)	Off	1	2	3	4	5	6	7					
		Gauge	1	2	3	4	5	6	7	8					
5	Lime	Measurement value (°dH)	<5	5-10	10-15	15-20	>20	Softened water	DI-Water						
		Gauge	1	2	3	4	5	6	7						
6	Chlorine	Measurement value (mg/l)	0	>0-50	50-100	100-150	150-200								
		Gauge	1	2	3	4	5								
7															
8	Factory setting	Factors setting	No	Yes											
		Gauge	1	2											
		Information: Actuate the selection switch for 5 Seconds when you want to reset the device to the factory setting (Yes - 2).													

Table 7.4.6.1 Settings

8 Safety / Maintenance / Repair Works

Maintenance works are the responsibility of the user. Damage to the device caused by not executing maintenance works are not subject to the manufacturer's warranty!

Cleaning the unit regularly increases its service life.

8.1 Regular Visual Controls

INFORMATION	
	<p>Visible damage to the unit!</p> <ul style="list-style-type: none"> • Inspect for visible damage on the device components before putting the device into operation. • Do not operate the unit when there is any visible damage. • Send a defective device for repair to the service centres of the manufacturer. • Have damaged components replaced with original parts from the manufacturer by a qualified professional person.

The following components should be checked periodically for signs of damage:

- The mains supply cable
- The foot switch and the electrical supply to the foot switch
- The steam hose (handpiece)
- O-ring of the pressure vessel screw cap (Chapter 8.2.1)
- O-ring of the nozzle (Chapter 8.2.2)
- Additionally inspect the optional water hose for correct securing (fixed-water supply or canister).

8.1.1 Cleaning the Sieve in the Water Connection

The sieve in the water connection may become clogged by particles or minerals in the water supply and the water supply to the device will be affected.

Intervals Depending on the water quality. At the latest when the pressure vessel is not correctly filled

Preparation

- Pull out the mains plug
- Close off the water supply to the device

Procedural Method

1. Remove the hose on the fixed-water supply (Figure 4.4.3-F)
2. Pull out the sieve with pliers
3. Clean the filter under running water
4. Replace the sieve again
5. Correctly reassemble the water connection and inspect it secure fit and leak tightness.

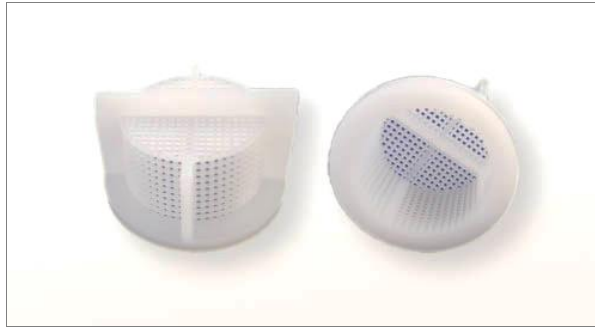

Figure 8.1.1.1: Sieve from different views

8.1.2 Cleaning the unit

Wipe the cooled unit and operating controls with a damp cloth on a regular basis. You can use a mild cleaning agent for this. Remove any dirt such as dust from the air inlets to ensure adequate ventilation.

If the unit is used for medical and health applications, disinfect the unit with a surface disinfectant after use for hygiene reasons

8.1.3 Disinfect nozzle and entire hand-piece

Switch off the unit and allow the nozzle and hand-piece to cool down.

Observe the instructions on the safety data sheet. Observe the instructions for using the disinfectant.

We recommend the following disinfectants for wiping the unit:

- Incidin Liquid Fa. Ecolab (gebrauchsfertige Schnelldesinfektion)
- Terralin protect by Schülke (observe dosage and exposure time).

8.2 Wear and Tear Parts

Wear and tear parts are excluded from the warranty

8.2.1 O-ring in the Pressure Vessel Screw Cap

Replacement Interval	Depending on the function and characteristics of the material.	
Item Number	107 0074	

8.2.2 O-ring Nozzle

Change interval	Depending on function and occurring leakage (water dripping from gland). Observe the service instructions.	
Item Number	105 7949	

8.2.3 Seal on the Collecting Tray

Replacement Interval	Depending on visible signs of wear (for example, cracks). Observe the service instructions.	
Item Number	105 7953	

8.2.4 Hose (handpiece)

Replacement Interval	Depending on visible signs of wear (for example, cracks). We recommend that the hose is completely replaced with the manual unit.	
Item Number	Observe the service instructions. 106 6873 Hose (1,4 m) 107 6020 Hose (12,3 m) 106 6835 Handpiece with hose (1,4 m) 109 0457 Handpiece with hose (2,3 m)	

8.3 Safety Valve

8.3.1 Inspect biannually

Inspect the safety valve in biannual intervals to ensure the safety according to the manufacturer's provisions.

	WARNING
	<p>Hot vapours/hot liquids Severe burns and risk of scalding</p> <ul style="list-style-type: none"> • Replace the safety valve when a malfunction is detected • Device damage will be caused by overpressure

Preparation The device must be depressurised and switched off.

Tools required 3 mm Allen key (or Torx T20)

- Procedural Method**
1. Open screws (Figure 8.3.1.1-A).
 2. Remove the cover (Fig 8.3.1.2-B) in the direction of arrow
 3. Turn the cone (Figure 8.3.1.3-C) by hand anti-clockwise until it stops.
 4. Securely screw the cover (heat protection for the terminals).
 5. Switch on the device and let it heat up until steam exits from the safety valve (audible hissing sound).
 6. Switch off the device again and wait until it has cooled down and is depressurised.
 7. Remove the cover (Fig 8.3.1.2-B).
 8. Tighten the cone by hand clockwise until it stops.
 9. Securely screw the cover (Figure 8.3.1.1-A).

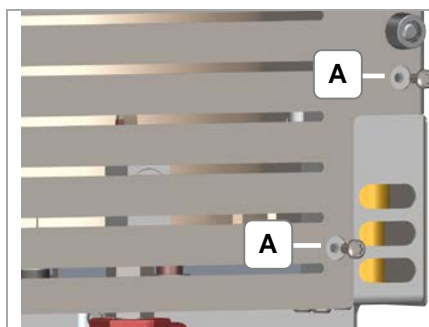

Figure 8.3.1.1: Screwing the safety valve, opening the cover

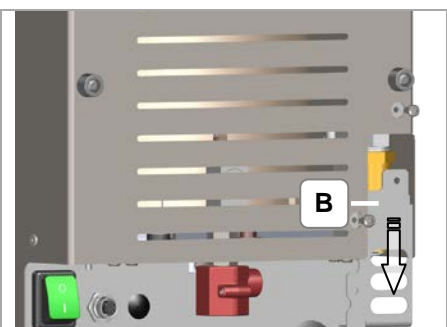

Figure 8.3.1.2: Removing the safety valve cover

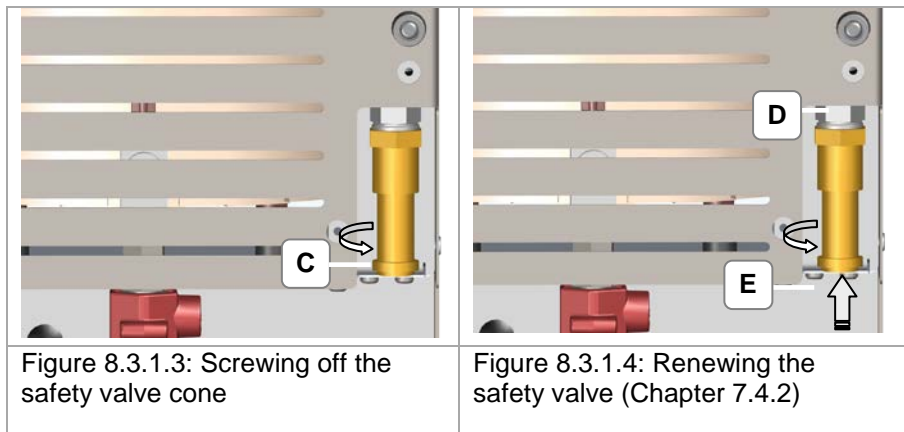



Figure 8.3.1.3: Screwing off the safety valve cone

Figure 8.3.1.4: Renewing the safety valve (Chapter 7.4.2)

8.3.2 Replacement every 3 years

	WARNING
	<p>Hot vapours/hot liquids Severe burns and risk of scalding</p> <ul style="list-style-type: none"> • Replace safety valve • Device damage will be caused by overpressure

Preparation The device must be depressurised and switched off.

Tools required 3 mm Allen key (or Torx T20), socket wrench SW 20, open-ended spanner 19 mm.

- Procedural Method**
1. Open the screws (Figure 8.3.1.1.A).
 2. Remove the cover (Figure 8.3.1.2-B) in the arrow direction.
 3. Screw off the safety valve with the socket wrench. Insert the socket wrench in the safety valve in the direction of arrow and unscrew it in an anti-clockwise direction (Figure 8.3.1.4-E). Hold the open-ended spanner against the base (Figure 8.3.1.4-D).
 4. Screw on a new safety valve with seal (Figure 8.3.1.1).
 5. Securely screw on the cover.
 6. Switch on the device and let it heat up and then inspect the screws and glands for leaks (no steam can leak out).

8.4 Repair Works

Contact the supplier or manufacturer of this device in case of repair works.

Repairs require expertise and may only be carried out by qualified personnel.

	WARNING
	<p>Energised parts in the device! Electric shocks!</p> <ul style="list-style-type: none"> • Unplug the unit from the mains supply before any repair works.

	CAREFUL
	<p>Escaping hot steam! Scalding!</p> <ul style="list-style-type: none"> • Only open the pressure tank screw cap on the filler neck when the device is depressurised. • Only dismantle pressure-carrying parts in the device when the device is depressurised! • Observe the gauge display (Chapter 3.6.3.1-D)! The device remains under pressure as long as one segment is illuminated on the value scale on the gauge. • Device can before opening to cool down.

	CAREFUL
	<p>Hot surfaces! Burns!</p> <ul style="list-style-type: none"> • Device can before opening to cool down.

	INFORMATION
	<p>Only original parts may be used for repair works.</p> <p>The CE Conformity Declaration can become invalid in certain instances by opening the device.</p> <p>The manufacturer assumes no liability for incurred damages due to unauthorised opening of the device.</p> <p>If the device needs to be returned to a service centre or to the manufacturer, then it must be ensured that the device has been emptied and is transported in a secure package.</p>

8.5

Preparing the Device for Shipping

If it is necessary to return the device to a service centre or to the manufacturer, then the following points must be noted:

- Let the appliance cool down and empty it completely.
- Remove the connected accessory: Connections for canister, fixed-water connection, foot switch, compressed air, mains supply cable
- Disinfect the surfaces.
- Pack the unit securely for transport in a suitable container, when possible in the original box.

8.6 Troubleshooting

Malfunction	Possible Cause	Remedying
Warning flashes Filling level flashes Signal tone sounds	<ul style="list-style-type: none"> Filling level in the pressure vessel is too low 	<ul style="list-style-type: none"> Fill the device (Chapter 6)
Operating pressure was not achieved Scale of values on the gauge flashes (set operating pressure) The pressure value achieved is not displayed in ascending order on the scale of values	<ul style="list-style-type: none"> Pressure vessel screw cap is not sealed completely Steam flows out from pressure tank screw cap 	<ul style="list-style-type: none"> Disconnect the device from the mains supply or switch off on the power switch Allow to cool down Tightly screw closed the pressure vessel screw cap. If steam escapes from the pressure vessel screw cap again, then replace the sealing ring (Chapter. 8.2.1)
	<ul style="list-style-type: none"> Heating malfunction 	<ul style="list-style-type: none"> Send the device to the service centre
Steam suddenly exits on the housing (rear side of the device) Possible one-off creaking sound from the device. Gauge flashes	<ul style="list-style-type: none"> Safety valve (Figure 3.6.2.1-B) has triggered 	<ul style="list-style-type: none"> Disconnect the mains plug or switch off the device at the mains switch For devices with compressed air: inspect whether the maximum permissible connection supply pressure was observed. Send the device to the service centre
For devices with pump: Pump is not pumping Filling level flashes Warning flashes	<ul style="list-style-type: none"> The 30 second waiting time was not observed Filling level too low 	<ul style="list-style-type: none"> Pumping operation starts initially after 30 seconds after switching on Fill the device manually with at least 2 litres of water (Chapter 6.2)

Malfunction	Possible Cause	Remedying
<p>For devices with pump:</p> <p>Pump operation does not switch off</p>	<ul style="list-style-type: none"> • The white hose in the canister has slipped upwards • Sieve in the water connection is clogged • Seals in the fixed-water supply are missing • Seal (black) for the water connection to the canister is missing • Air in water supply 	<ul style="list-style-type: none"> • Unscrew the canister lid. Adjust the white water hose and filling level cable with float switch to the same level bring (Figure 4.5.5). Subsequently repeat the commissioning process for the pump. • Remove the sieve and clean it (Chapter 8.1.1) • Insert a seal in the fixed-water connection (Figure 4.4.1) • Insert a seal in the water connection to the canister. Seal may remain displaced on the device, on the connection to the device when unscrewing the water connection (Chapter 4.5.1-A).
<p>Operating display does not illuminate</p>	<ul style="list-style-type: none"> • Malfunction 	<ul style="list-style-type: none"> • Send the device to the service centre
<p>Service flashes</p> <p>Signal tone sounds</p> <p>No steam operation is possible in soft or strong mode</p>	<ul style="list-style-type: none"> • Descaling was not carried out (safety shut-down) 	<ul style="list-style-type: none"> • Descale the device
<p>Warning flashes</p> <p>No steam operation is possible in soft or strong mode</p>	<ul style="list-style-type: none"> • Foot switch not connected to the device (steam operation via fixed nozzle) 	<ul style="list-style-type: none"> • Inspect the plug for the foot switch for whether this is screwed in up to the stop (Chapter 4.2.1) • Plug in the foot switch plug (Chapter 4.2.1)
<p>Warning illuminates</p> <p>Heating does not heat up - scale of values on the gauge does not flash even though steam operation soft or strong is activated</p>	<ul style="list-style-type: none"> • Ambient temperature of the device is too high 	<ul style="list-style-type: none"> • Pay attention to the environmental conditions specified by the manufacturer (Chapter 4)
	<ul style="list-style-type: none"> • 	<ul style="list-style-type: none"> •

Malfunction	Possible Cause	Remedying
<p>No compressed air discharge possible with actuation</p>	<ul style="list-style-type: none"> • Steam pressure < 3 bar • Compressed air is not connected • No compressed air supply ready 	<ul style="list-style-type: none"> • Wait until the device is ready for operation (operating pressure) • Inspect the compressed air connection • Inspect the compressed air supply
<p>No steam discharge possible with actuation</p> <p>Device is ready for operation</p> <p>Steam mode soft or strong is activated</p>	<ul style="list-style-type: none"> • Solenoid valve defective 	<ul style="list-style-type: none"> • Send the device to the service centre

9

Decommissioning and Disposal



This device must not be disposed of with household waste (municipal rubbish bin).

The device can be returned to the manufacturer for disposal or must be disposed of in accordance with the local waste regulations of the local waste management company.

Drain the unit.

Disinfect the surfaces.

10

Manufacturer's Address / Contact Address

Elma Schmidbauer GmbH

Gottlieb-Daimler-Str. 17, D-78224 Singen

Telephone Head Office +49 (0) 7731 / 882-0

Fax Head Office +49 (0) 7731 / 882-266

info@elma-ultrasonic.com

www.elma-ultrasonic.com

Technical Support

support@elma-ultrasonic.com